

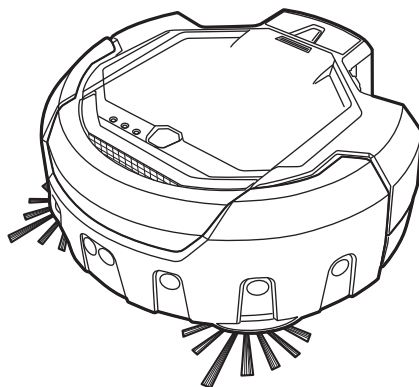

GB	Robotic Cleaner	INSTRUCTION MANUAL	7
CS	智能扫地机器人吸尘器	使用说明书(保留备用。)	18
CT	自動掃地機器人	使用說明書	32
KR	로봇 청소기	사용 설명서	41
ID	Robot Pembersih	PANDUAN PENGGUNA	52
VI	Máy Hút Bụi Tự Động	HƯỚNG DẪN SỬ DỤNG	63
TH	หุ่นยนต์ดูดฝุ่น	คู่มือการใช้งาน	74

DRC200

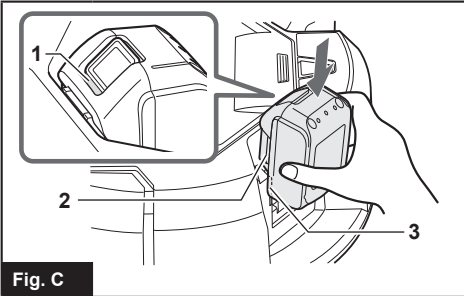

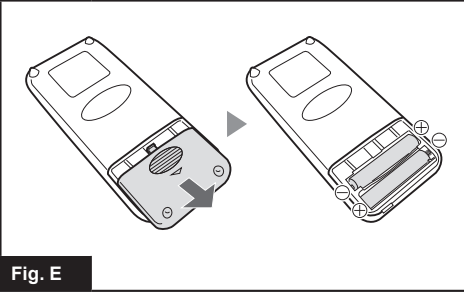
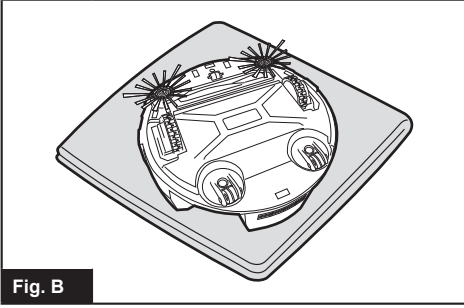
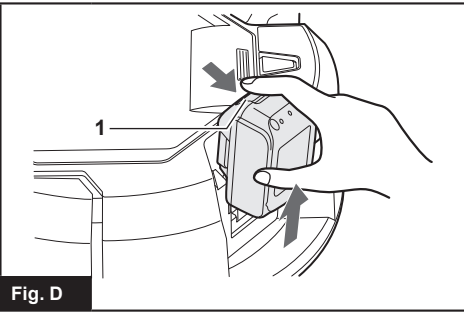
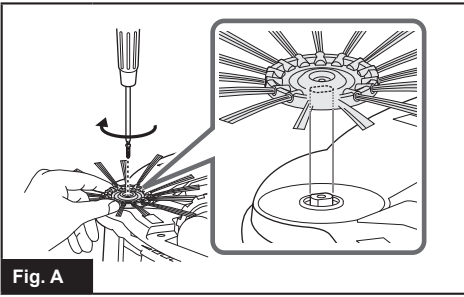

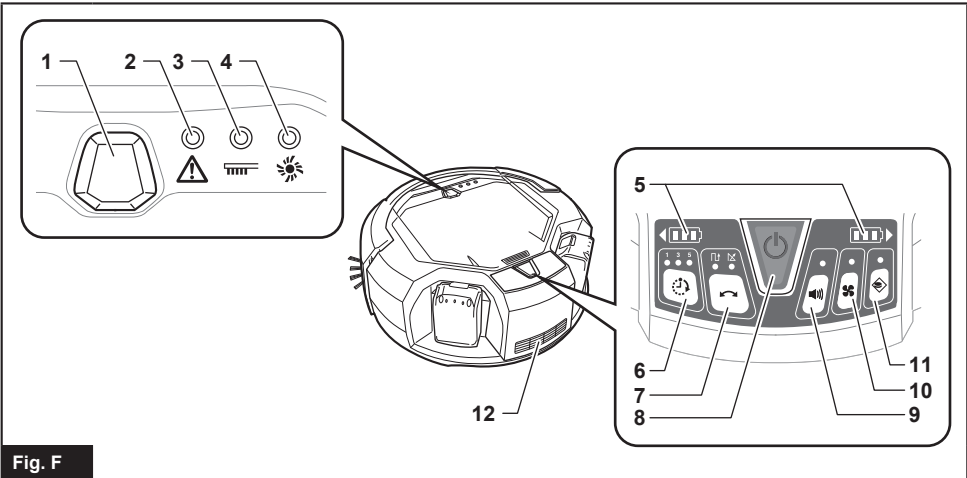

Fig. F

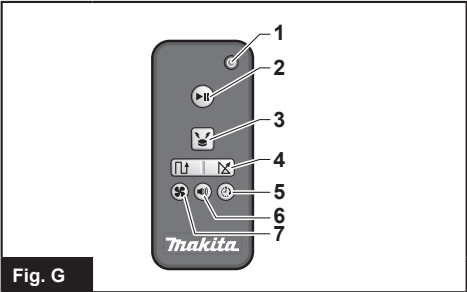

Fig. G

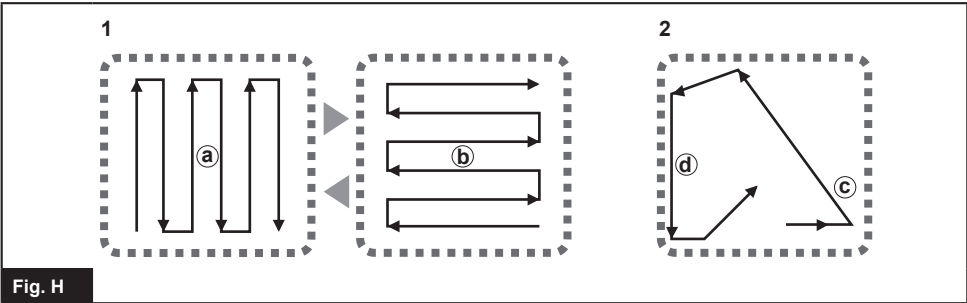

Fig. H

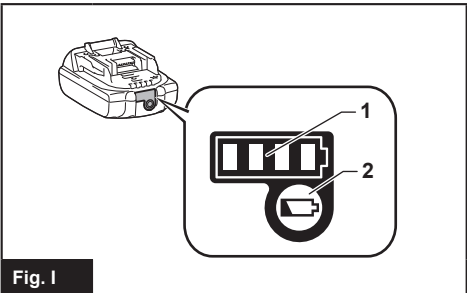

Fig. I

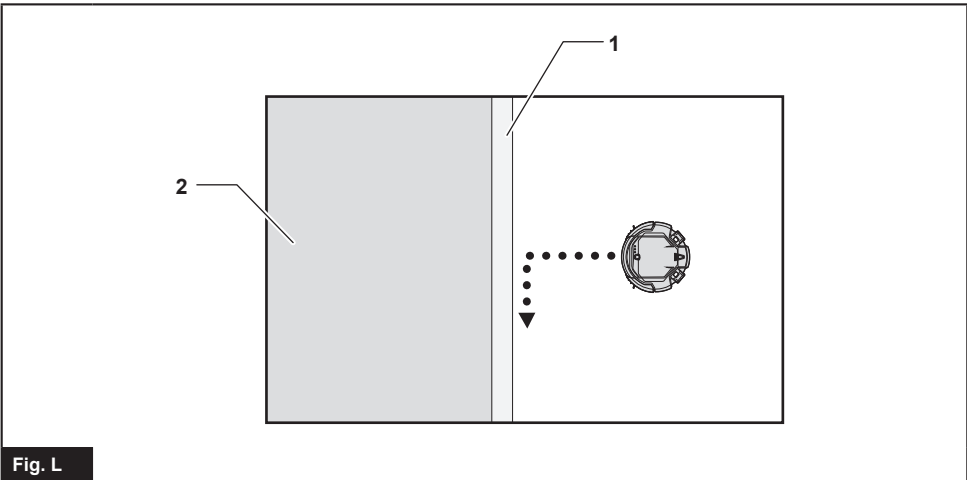
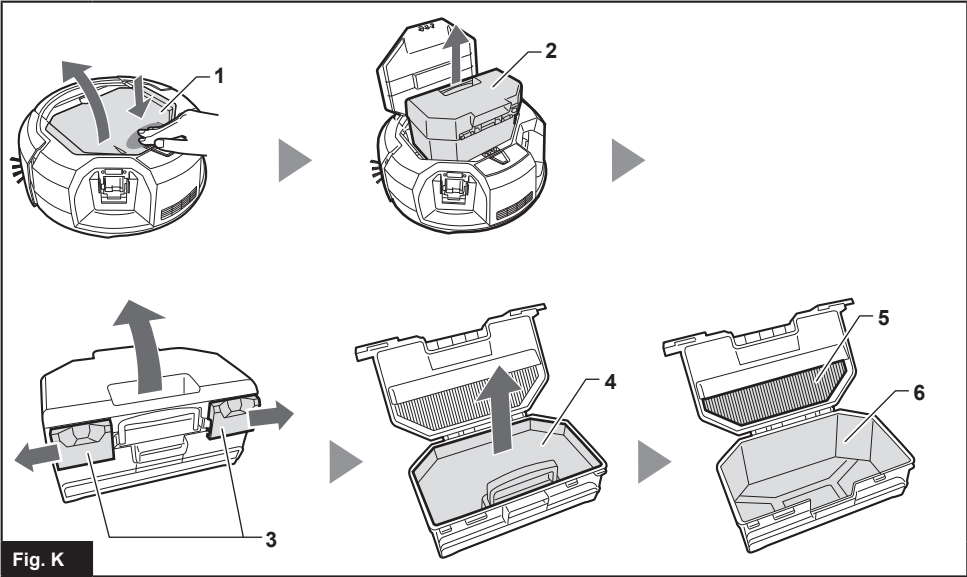
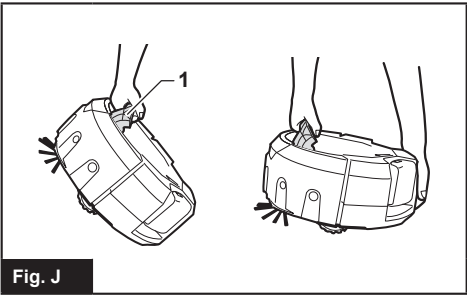

Fig. M

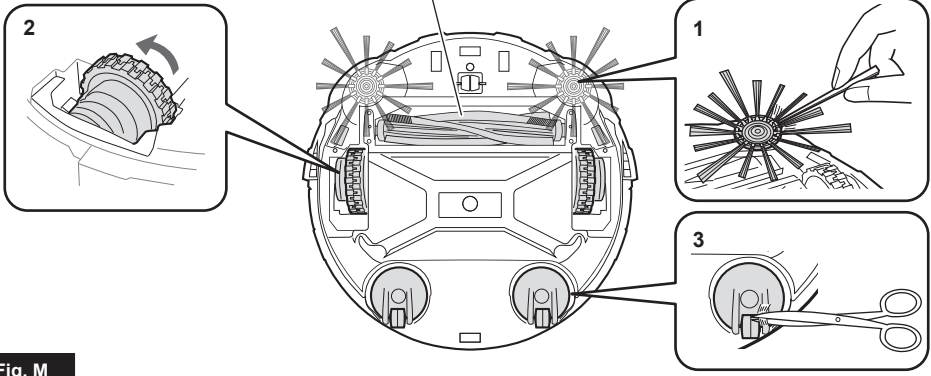
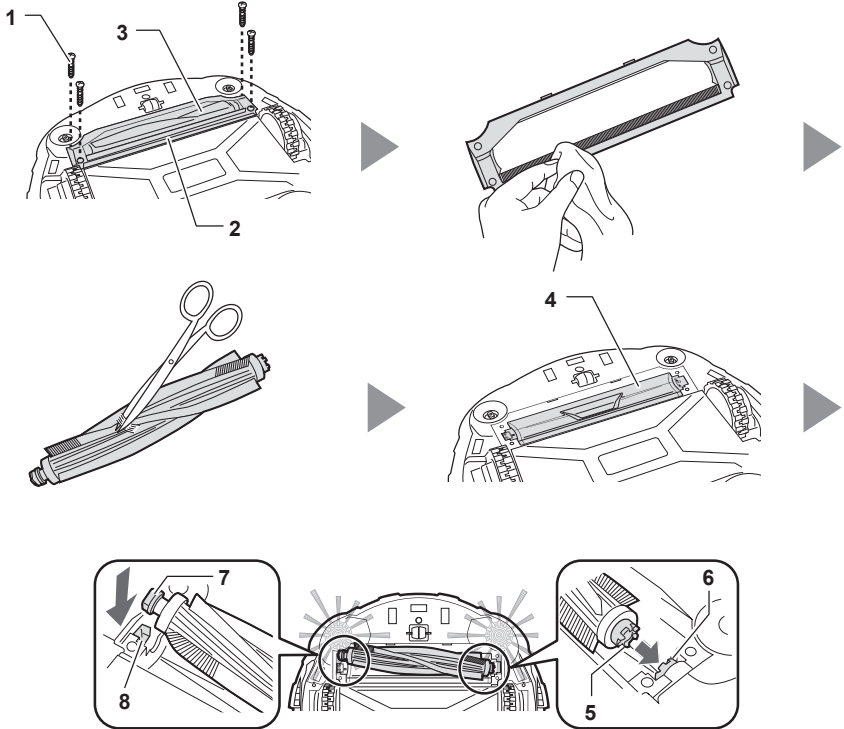
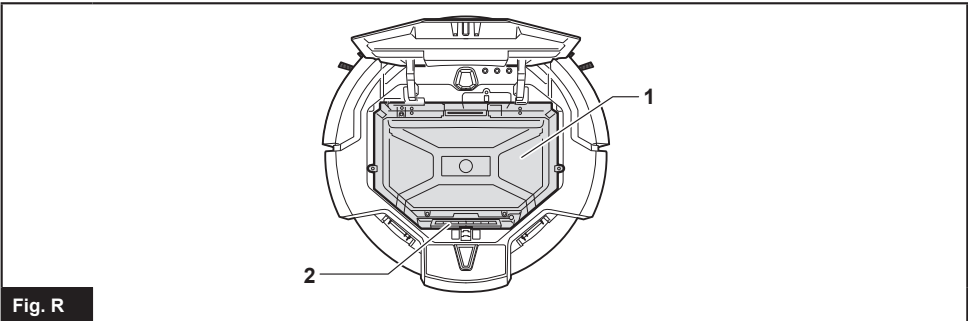
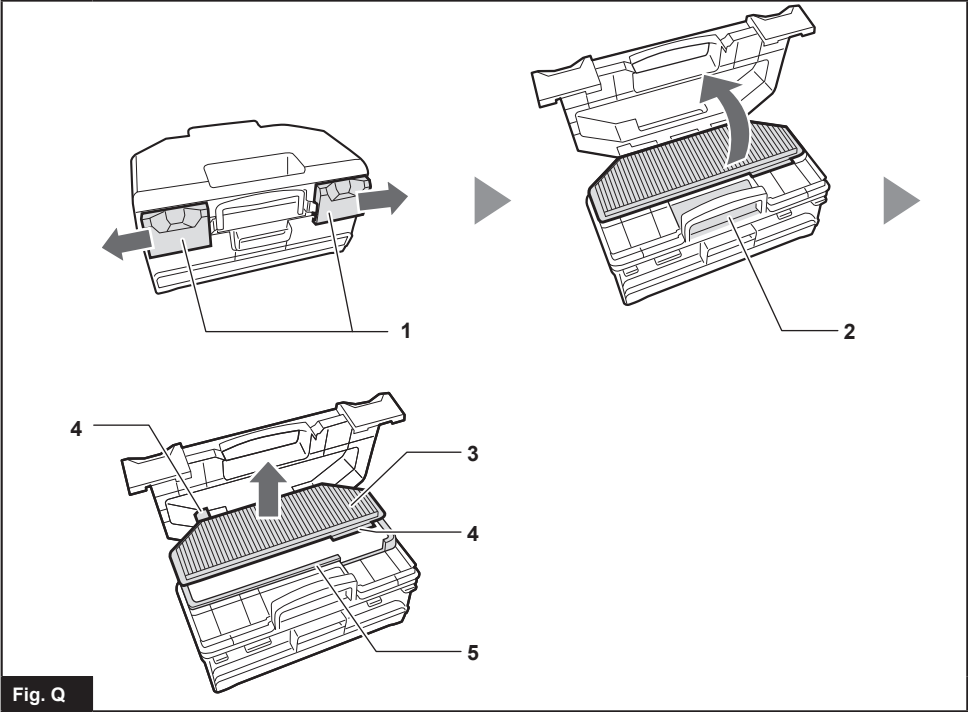
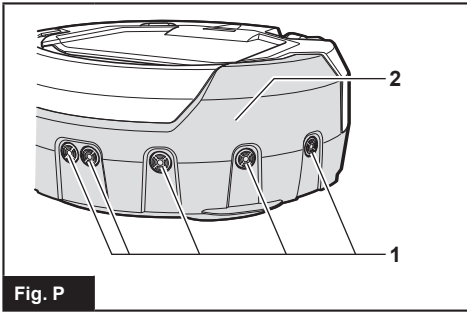
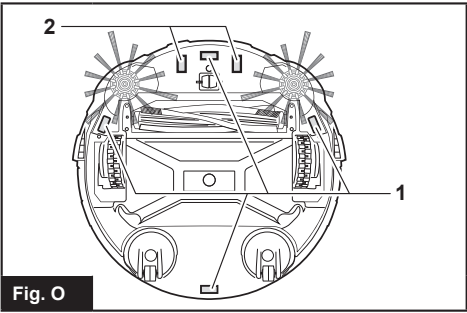

Fig. N





ENGLISH (Original instructions)

WARNING: This machine is not intended for use by persons (including children) with reduced physical, sensory or mental capabilities, or lack of experience and knowledge. Children should be supervised to ensure that they do not play with the appliance.

SPECIFICATIONS

Standard battery cartridge	BL1815N, BL1820B, BL1830B, BL1840B, BL1850B, BL1860B
Battery life (using optional lithium ion batteries)	Approx. 120 min. using two BL1830s (18 V, 3 Ah ea.) Approx. 200 min. using two BL1850s (18 V, 5 Ah ea.)
Bin capacity	2.5 L
Dimensions (w/l/h) (incl. BL1830 batteries)	Approx. 460 x 460 x 180 mm
Weight (incl. two BL1830 batteries)	Approx. 7.8 kg

- The specifications here are subject to change without notice, due to our continuing program of research and development.
- Specifications may differ from country to country.

Symbols



Read instruction manual.



Do not step or put objects on the Robotic Cleaner.



Do not use the Robotic Cleaner near an open flame or flammable and/or dangerous materials.



Clean the cliff sensors on the bottom face if they are dirty or wet.

Intended use

This is the Robotic Cleaner intended for cleaning indoor floors. The remote controller connects to the Robotic Cleaner by wireless (2.4 GHz ZigBee).

SAFETY PRECAUTIONS

WARNING

Do not use the Robotic Cleaner near or vacuum up inflammable substances.

This may result in explosion or fire.

- Kerosene, gasoline, incense, candles
- Benzine, thinner
- Cigarette butts
- Toner or other combustible substances
- Carpet cleaner or other foamy substances

Do not use the Robotic Cleaner in wet locations, locations that may become wet, or locations with high temperatures and humidity. Also, do not vacuum up water.

This may result in electric shock, short-circuit, fire, deformation or malfunction.

- Kitchens and other areas where water is used
- Bathrooms
- Shower rooms
- Attics, etc.

Do not touch the Robotic Cleaner with wet hands.

This may result in electric shock.

Do not use the Robotic Cleaner around stoves or other heating equipment.

This may result in electric shock, short-circuit, fire, deformation or malfunction.

Do not use the Robotic Cleaner in the following types of locations.

This may result in electric shock or injury.

- Near infants or persons with reduced physical, sensory or mental capabilities, or lacking in the necessary experience and knowledge
- Near animals
- Near large numbers of people or highly trafficked areas

Do not allow unsupervised children or persons who are unable to express their will or operate the Robotic Cleaner by themselves to use the Robotic Cleaner.

This may result in electric shock or injury.

Discontinue operation immediately in the event of an abnormality or malfunction such as the following.

Failure to observe this instruction may result in smoke, fire or electric shock.

- The Robotic Cleaner will not operate even though it is turned ON.
- The Robotic Cleaner is deformed or abnormally hot.
- The Robotic Cleaner stops sometimes during operation.

- The Robotic Cleaner makes abnormal noises during operation.
- The Robotic Cleaner gives off a burnt smell.

Turn OFF the Robotic Cleaner in locations where use is prohibited.

Failure to observe this instruction may cause medical equipment to operate improperly. Be sure to follow the instructions of each medical institution when using equipment that emits radio waves inside medical institutions.

Do not use the Robotic Cleaner in narrow and unenclosed high locations.

This may cause the Robotic Cleaner to fall from the area, resulting in injury or malfunction.

- Stairs
- On top of a table, shelf, dresser, refrigerator, etc.
- Mezzanines, lofts, floors with a direct drop onto stairwells or entranceways, etc.
- Locations with an incline of 10° or more

Do not expose the Robotic Cleaner to direct sunlight or infrared rays.

Improper operation due to a sensor error may cause the Robotic Cleaner to fall, resulting in injury or malfunction.

- Halogen heaters
- Remote controls or sensors, etc.
- Sun rays entering through frosted glass

Move any objects that may cause an accident in the event of contact with the Robotic Cleaner.

Failure to observe this instruction may result in injury due to objects tipping over or falling.

- Lit candles, vases, etc.
- Electronics with controls located around the same height as the Robotic Cleaner.

Do not cover the Robotic Cleaner.

This may result in fire due to overheating.

Do not ride or place heavy objects on the Robotic Cleaner. Do not apply strong physical shocks.

This may result in injury, damage or malfunction. In particular, pay close attention to children around the Robotic Cleaner.

Never modify the Robotic Cleaner.

This may result in fire, electric shock or injury. Consult the dealer where you purchased the Robotic Cleaner for repairs.

Do not block or insert metallic or easily combustible foreign object into the suction or exhaust openings. Also, do not use the Robotic Cleaner around objects that may block the suction opening.

This may result in electric shock, fire or malfunction.

Do not heat or expose the Robotic Cleaner to fire or leave it in a hot location such as near a fire or stove, exposed to direct sunlight, or inside a vehicle under the blazing sun.

This may result in short-circuit, fire, or cause the battery to leak fluid or burst.

Do not wash or expose the Robotic Cleaner* to water or detergents.

This may result in electric shock, short-circuit or fire.

* Excluding the main brush, bottom plate, side brushes, dust box and filter

Do not touch the drive wheels or insert hands or feet under the Robotic Cleaner during operation.

This may result in injury. In particular, pay close attention to children around the Robotic Cleaner.

Do not block or insert foreign matter into the Robotic Cleaner's sensors.

This may result in operational failure, injury due to the Robotic Cleaner falling as a result of improper operation, or malfunction.

Do not attach tape to the sensors or wheels. Do not alter the bumper or wheel shapes or press the bumper with excessive force.

This may result in operational failure, injury due to the Robotic Cleaner falling as a result of improper operation, or malfunction.

Periodically clean each sensor.

Failure to observe this instruction may result in operational failure, injury due to the Robotic Cleaner falling as a result of improper operation, or malfunction.

Do not use boundary tape (sold separately) that is dirty, peeling or torn.

This may result in injury due to the Robotic Cleaner falling as a result of operational failure.



Do not use the Robotic Cleaner in the following locations.

This may cause other equipment to operate improperly.

- Inside a hospital or around medical equipment
- Inside an airplane
- Around electronic equipment that requires precision control or uses weak signals.

Be sure to keep the Robotic Cleaner and the remote control more than 15 cm away from implantable cardiac pacemakers and defibrillators.

Failure to observe this instruction may result in malfunction of the medical devices.

Do not insert foreign matter into the gaps and openings.

This may result in electric shock or injury.

Be careful not to get your fingers caught when cleaning the Robotic Cleaner.

This may result in injury.

Be sure to read this INSTRUCTION MANUAL thoroughly before using the Robotic Cleaner.

Failure to observe this instruction may result in injury or malfunction.



Immediately discontinue use of the battery cartridge if an unpleasant odor, battery leakage, abnormal heating, deformation, or discoloration is observed.

Failure to observe this instruction may result in malfunction.

Do not use the Robotic Cleaner outdoors or in locations where it may wander outdoors.

This may result in malfunction.

Do not use the Robotic Cleaner in the following locations.

This may result in malfunction.

- Locations where cooking oil particles or other oil components are suspended in the air
- Locations where aerosol sprays or chemical products are used, such as barber shops, beauty salons, and dry cleaning shops
- Dusty locations

Do not use the Robotic Cleaner in the following locations.

This may damage floor coverings or scratch floor surfaces.

- Locations with easily damaged floor coverings (sheepskin, felt materials, etc.)
- Unfinished wood or marble floors
- Freshly waxed floors

Do not use the Robotic Cleaner on floor coverings with a long pile length (7 mm or more).

This may result in damage to the floor coverings or cause the Robotic Cleaner to malfunction.

Do not use the Robotic Cleaner on hard, uneven floor surfaces such as concrete floors, etc.

This may result in increased brush and wheel wear.

Do not use the Robotic Cleaner if the brushes or wheels are worn.

This may result in scratched floor surfaces.

Discontinue operation and consult the dealer where you purchased the Robotic Cleaner.

Remove any sandy dirt adhering to the main brush, side brushes and wheels.

Failure to observe this instruction may result in scratched floor surfaces.

Do not vacuum up the following items.

This may scratch or clog the inside of the Robotic Cleaner or result in malfunction.

- Liquids or wet garbage
- Chemicals or oils
- Pet excrement
- Large amounts of sand or powder
- Sharp objects (glass, blades, pins, etc.)
- Large paper or vinyl garbage
- Cord or string

Clean the filter after vacuuming up fine powder (plaster, cement, chalk, etc.).

Failure to observe this instruction may result in malfunction.

Do not use the Robotic Cleaner if the filter is clogged or the sensors are soiled.

This may result in malfunction.

Do not oil the rotating brush or other moving parts.

This may result in plastic cracking.

SAVE THESE INSTRUCTIONS.

Battery tool use and care

1. **Recharge only with the charger specified by the manufacturer. A charger that is suitable for one type of battery pack may create the risk of fire when used with another battery pack.**

2. **Use power tools only with specifically designated battery packs. Use of any other battery pack may create the risk of injury or fire.**
3. **When (the) battery pack is not in use, keep it away from paper clips, coins, keys, nails, screws and other small metal objects that can make a connection from one terminal to another.**
4. **Under extreme conditions, liquid may be ejected from the battery; avoid contact. If accidental contact occurs, flush with water.**

Important safety instructions for the battery cartridge

1. **Before using the battery cartridge, read all instructions and precautionary markings on (1) the battery charger, (2) the battery, and (3) product using the battery.**
2. **Do not disassemble the battery cartridge.**
3. **If operating time has become significantly shorter than usual, stop operating immediately. It may result in a risk of overheating, possible burns and even an explosion.**
4. **If electrolyte gets into your eyes, rinse them out with clear water and seek medical attention right away. It may result in loss of your eyesight.**
5. **Do not short-circuit the battery cartridge:**
 - (1) **Do not touch the terminals with any conductive material.**
 - (2) **Avoid storing the battery cartridge in a container with other metal objects such as nails, coins, etc.**
 - (3) **Do not expose the battery cartridge to water or rain.**

A battery short-circuit can cause a large current flow, overheating, possible burns and even a breakdown.
6. **Do not store the Robotic Cleaner and battery cartridge in any location where the temperature may reach or exceed 50°C (122°F).**
7. **Do not incinerate the battery cartridge even if it is severely damaged or is completely worn out. The battery cartridge can explode in a fire.**
8. **Be careful not to drop or strike the battery cartridge.**
9. **Do not use a damaged battery cartridge.**
10. **Follow your local regulations relating to the disposal of battery cartridges.**

SAVE THESE INSTRUCTIONS.

⚠CAUTION: Only use genuine Makita batteries. Using non-genuine Makita batteries, or batteries that have been altered, may result in the battery bursting causing fires, personal injury and damage. It will also void the Makita warranty for the Makita tool and charger.

Tips for maintaining maximum battery life

1. Charge the battery cartridge before it becomes completely discharged. Always stop operation and charge the battery cartridge when you notice less tool power.
2. Never recharge a fully charged battery cartridge. Overcharging shortens the battery service life.
3. Charge the battery cartridge within a room temperature range of 10°C - 40°C (50°F - 104°F). Let a hot battery cartridge cool down before charging it.
4. It is recommended that you charge the battery cartridge before storing it for a long period (more than six months).

Tool/battery cartridge protection system

The Robotic Cleaner is equipped with a tool/battery cartridge protection system that automatically cuts OFF the power to the motor to extend the life cycle of the Robotic Cleaner and the battery cartridges. The Robotic Cleaner automatically stops under the following conditions.

Overload

When the Robotic Cleaner is overloaded and an abnormally high current is drawn, the Robotic Cleaner automatically stops without any indication.

To restart the Robotic Cleaner, turn the power OFF, eliminate the cause of the overload, and then turn the power back ON.

Overheating

When the Robotic Cleaner overheats, the  lamp flashes 5 or 7 times for each sequence and the Robotic Cleaner automatically stops.

In this case, leave the Robotic Cleaner to cool down before turning the power back ON.

Overdischarge





When the remaining battery level becomes low, the Robotic Cleaner automatically stops and does not respond to any switch operations.







In this case, remove and recharge the battery cartridges.

BUTTONS AND INDICATORS









You can find details of the parts by searching for the figure number corresponding to each part in this document (e.g. search for "Fig. F-8" for the  POWER button).

Robotic Cleaner (Fig. F)

1. Pilot lamp
2.  Troubleshooting lamp
3.  Filter maintenance lamp
4.  Brush maintenance lamp
5.  Battery indicators (for the right-hand and left-hand battery cartridges)
6.  Timer button and lamps

7.  Cruise mode button and lamps
 : Pattern mode
 : Random mode
8.  POWER (start/stop) button
9.  Buzzer button and lamp
10.  Vacuum button and lamp
11.  Boundary sensor button and lamp

Remote control (Fig. G)

1.  POWER OFF button
2.  Start/Stop button
3.  Location beacon button
4.  /  Cruise mode buttons
5.  Timer button
6.  Buzzer button
7.  Vacuum button

PRIOR TO USE

Assembly and battery installation

 **CAUTION:** Always be sure to turn OFF the Robotic Cleaner before carrying out any work on the Robotic Cleaner.

Supplied accessories

Check that the items in the following list are included in the package.

- Size AAA (LR03) batteries (x2)
- Side brushes (x4, incl. two spare brushes)
- Screws for side brush installation (x4)
- Boundary tape (15 m x1)
- Instruction Manual (x1)
- Quick start guide (x1)
- Notes on use (x1)

Installing the side brushes (Fig. A)

Install the side brushes on both sides of the bottom front of the Robotic Cleaner.

 **NOTICE:** Before work, be sure to spread a rug or other cushioning material on the floor to prevent damage to the floor and Robotic Cleaner (Fig. B).

1. Place the side brush on the rotating shaft head on the Robotic Cleaner with the groove of the brush fitted to the shaft head.
2. Secure the side brush using the supplied screw.

 **NOTICE:** Make sure that the Robotic Cleaner is operated with the side brushes installed.

Installing the battery cartridges

Align the groove (Fig. C-2) on the battery cartridge with the tongue (Fig. C-3) on the battery dock and slip it into place. Insert it all the way until it locks in place with a small click.

If you can see the red indicator (Fig. C-1) on the upper side of the release button, the battery cartridge is not completely locked.

 **CAUTION:** Care must be taken in installing the battery cartridges so that fingers are not caught between the dock and the battery cartridge.

The Robotic Cleaner operates with only one battery cartridge installed on either of the battery dock.

To remove the battery cartridge, slide it from the battery dock while pressing the release button (Fig. D-1) on the cartridge.

Installing batteries in the remote control (Fig. E)

Slide off the battery compartment lid, and insert two AAA size (LR03) batteries, taking care to align correctly the polarity (+/-).





NOTICE: Do not use new and old batteries together, nor use different types of battery together.

NOTICE: Remove the batteries, if the remote control is not going to be used for a long time.

CAUTION: If the skin or eyes come into contact with electrolyte leaking from the batteries, immediately flush with water.

Pairing the Robotic Cleaner and the remote control

The Robotic Cleaner comes already paired with the remote control. However, the pairing process must be performed again if you replace the remote control.

1. Press and hold the  Timer (Fig. F-6) and  Cruise mode (Fig. F-7) buttons simultaneously on the Robotic Cleaner until the buzzer beeps twice.
2. Press and hold the  Timer (Fig. G-5) and  Location beacon (Fig. G-3) buttons simultaneously on the remote control until the buzzer beeps once.

If pairing fails and the buzzer beeps 5 times, retry pairing again.

Organizing rooms

To ensure smooth cruising

- Shut the doors to the room. If the difference in the level of the door threshold is small enough that the Robotic Cleaner can pass over it without problem, the door can also be left open so that the Robotic Cleaner continues and cleans the adjoining room.
- Place obstacles in front of easily damaged furniture, etc.
- Place obstacles to prevent the Robotic Cleaner from entering locations where it may become stuck, such as under low shelves.
- Move tall, thin and unstable objects and other easily tipped over objects to another room.
- Lock the wheels of carts or other objects, or move them to another room.
- Arrange electrical cords along the walls.
- Move cushions, books or other objects that may impede the Robotic Cleaner from cruising to another room.
- Raise the parts of curtains or other objects that droop onto the floor.
- Move any floor coverings with easily pulled-out strands or differences in level and floor coverings that are thin and slide easily to another room.
- Fold any floor covering tassels beneath the floor coverings.
- Put away any small or expensive objects that may be easily vacuumed up.

- Put away any cords, belts, strings, thin papers, or plastic bags, lying on the floor.
- Retract any retractable floor power sockets.
- Cover any gratings dividing floor sections with boards, etc. as the Robotic Cleaner may detect them as boundaries and fail to move across them.

Preventing the Robotic Cleaner from falling

- If the cleaning area contains a flight of stairs or other section where the Robotic Cleaner may fall down, in order to keep the Robotic Cleaner out of the section, place objects with a height of 15 cm or taller and that are heavy enough to withstand the impact of the Robotic Cleaner in front of the section.
- Block sunlight and infrared rays with curtains. (The Robotic Cleaner may fall to a lower level when backing up to avoid sunlight or infrared rays.)
- Close aluminum sash doors. (The Robotic Cleaner may not detect the difference in level between the aluminum sash rail and the floor and may fall out of the door.)
- Move any floor coverings near differences in level to another room. (The Robotic Cleaner may not detect the difference and may fall.)

NOTE

- Do not use the Robotic Cleaner near or to vacuum up flammable substances. (It may result in explosion or fire.)
- Do not use the Robotic Cleaner in wet locations, locations that may become wet, or locations with high temperature and humidity. Also, do not vacuum up water. (This may result in electric shock, short-circuit, fire, deformation or malfunction.)
- Do not use the Robotic Cleaner in locations where the distance from the wall to a difference in level is approx. 1 m or less. (In rare cases the Robotic Cleaner may fall while backing up.)
- Do not use the Robotic Cleaner in areas where barriers that the Robotic Cleaner cannot climb over are located in the vicinities of walls or obstacles. The Robotic Cleaner may get stuck on the barrier while moving backward to avoid the wall or the obstacle.
- Deactivate any home security systems, etc. (The Robotic Cleaner may be mistakenly detected as an intruder.)
- The Robotic Cleaner may not avoid differences in level of 5.5 cm or less.
- Noise may appear on TV screens during operation. (This is not a malfunction of the television.)
- Do not leave the Robotic Cleaner for long periods with the battery cartridge installed. (The battery electrolyte may leak.)
- Do not turn the Robotic Cleaner upside down with the battery cartridge installed. (A button may be pressed, resulting in unintended operation.)

OPERATION

The Robotic Cleaner cruises around on the floor according to the preset cruising mode, avoiding obstacles using ultrasonic sensors (Fig. P-1), and captures dust and dirt and other debris on the route using the side brushes, main brush, and vacuum fan. However, the sensors may not detect an obstacle in some situations. If your Robotic Cleaner hits an obstacle, the Robotic Cleaner's bumper (Fig. P-2) absorbs impact and changes the direction of travel.

NOTE: There may be cases where the Robotic Cleaner could not pass over the barriers at the height of up to 1.5 cm, even though the Robotic Cleaner is designed to pass over such barriers.

NOTE: The Robotic Cleaner may avoid an area where is colored in black, having black wood-grain patterns, or an area made of glass.

NOTE: After a cleaning cycle is completed, some dust and dirt may remain under certain conditions.

NOTE: Wireless communication may be interrupted or blocked under the following conditions:





- Inside structures built with reinforced concrete or metallic building materials
- When the Robotic Cleaner is behind an obstacle
- Near radio communication equipment that uses the same frequency band
- Near devices that generate electromagnetic fields (microwave ovens, etc.) or static electricity, or that cause radio wave interference

Basic operations

CAUTION: Always make sure that the Robotic Cleaner is turned OFF before adjusting or checking any function on the Robotic Cleaner.

NOTICE: If dew condensation has occurred, turn OFF the Robotic Cleaner and wait until the Robotic Cleaner dries up, before restarting operation.

NOTICE: All settings are not cleared when the Robotic Cleaner is turned OFF. Be sure to confirm that the settings are right by the lamps (Figs. F-6, 7, 9, 11) on the Robotic Cleaner to prevent unexpected operation.



1. Press the  POWER button (Fig. F-8) on the Robotic Cleaner.
The Robotic Cleaner enters standby mode and the  Battery indicator (Fig. F-5) lights up. (For details, see "Battery indicator on the Robotic Cleaner" below.)
2. Press the  Cruise mode button (Fig. F-7) on the Robotic Cleaner repeatedly to select mode, or press the  or  Cruise mode button (Fig. G-4) on the remote control.
The selected mode lamp lights up. (For details, see "Cruise mode" below.)

3. Press the  POWER button (Fig. F-8) on the Robotic Cleaner or the  Start/Stop button (Fig. G-2) on the remote control to start cleaning.

The pilot lamp (Fig. F-1) flashes and the buzzer beeps while cleaning.

To pause the cleaning operation, perform step 3 again.

To resume the cleaning operation, perform step 3 again.





To turn OFF the Robotic Cleaner, press and hold the  POWER button (Fig. F-8) on the Robotic Cleaner until all indicators turn OFF, or press the  POWER OFF button (Fig. G-1) on the remote control.

CAUTION: Do not get a close look at the pilot lamp light, or avoid the light getting in your eyes. Doing so may harm your eyes.

Battery indicator on the Robotic Cleaner

The battery indicator located on the corresponding battery cartridge side lights up and indicates the remaining power of the battery cartridge.

NOTICE: The table below provides a rough indication of the remaining battery power. The remaining amount may vary depending on the conditions of use and the room temperature.







	50% or more
	Between 20% and 50%
	20% or lower
	Empty/No battery cartridge installed
	Battery error

Battery indicator on the battery cartridge

The remaining power can also be checked using the battery indicator (Fig. I-1) on battery cartridges with model numbers ending in the letter "B."

Remove the battery cartridge and press the  button (Fig. I-2).

NOTICE: The table below provides a rough indication of the remaining battery power. The remaining amount may vary depending on the conditions of use and the room temperature.

	75% or more
	Between 50% and 75% (incl. 50%)
	Between 25% and 50%
	25% or lower
	Empty
	Battery error

Cruise mode

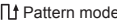
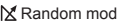
 Pattern mode	Application: Large floors with less obstacles such as in a well-organized warehouse and long gallery. Description (Fig. H-1): The Robotic Cleaner repeats a cycle of vertical (a) and horizontal (b) travels.*
 Random mode	Application: Floors with many obstacles such as in an office. Description (Fig. H-2): The Robotic Cleaner repeats a cycle of bouncing off (c) and along-the-wall (d) travels.

* Depending on the conditions encountered, the actual trail of the Robotic Cleaner may differ from this chart.

NOTE: The Robotic Cleaner could not clean a narrow area where the Robotic Cleaner could not travel or where is out of the reach of the side brush.

NOTE: After a cleaning cycle is over, some dust may remain on the floor in some conditions.

Sleep mode

If the Robotic Cleaner is left as it is for approx. 5 minutes in standby mode, the Robotic Cleaner automatically enters sleep mode to save the batteries, and the pilot lamp (Fig. F-1) slowly flashes. The Robotic Cleaner also enters sleep mode when the auto-on timer has been activated.

To return to standby mode, perform step 3 in "Basic operations."

NOTICE: Changes of settings and starting of cleaning operations are not possible in this mode.

Carrying the Robotic Cleaner

CAUTION: Before carrying the Robotic Cleaner, be sure to turn OFF the Robotic Cleaner.

CAUTION: Care must be taken that your hand never be caught between the handle and the Robotic Cleaner's body.



Grip the handle (Fig. J-1).

NOTICE: If you support the rear bottom of the Robotic Cleaner with another hand, care must be taken so as not to lift that side too much as the dust and dirt in the Robotic Cleaner drop out of the main brush opening.

NOTICE: Do not haul the Robotic Cleaner.

Emptying the bin

Empty the bin after every use to keep the Robotic Cleaner operating at peak performance.

1. Press and hold the  POWER button (Fig. F-8) on the Robotic Cleaner until all indicators turn OFF, or press the  POWER OFF button (Fig. G-1) on the remote control to turn OFF the Robotic Cleaner.
2. Press and release the top lid (Fig. K-1) to unlock it, and then fully open the lid.
3. Take out the dust box (Fig. K-2).
4. Undo both locks (Fig. K-3), and open the dust box lid.
5. Take out and empty the upper bin (Fig. K-4).
6. Remove small clumps of dust from the filter (Fig. K-5) and empty the lower bin (Fig. K-6).
7. Replace the dust box in the Robotic Cleaner in the reverse sequence.

Advanced operations

The following features can be set only when the Robotic Cleaner is in standby mode (see step 1 in "Basic operations").

Saving power

The Robotic Cleaner can capture most visible dust without using the vacuum fan. If fine dust does not need to be removed, turning OFF the vacuum fan saves the battery power to prolong the operating time of the Robotic Cleaner.

In standby mode, press the  Vacuum button on the Robotic Cleaner (Fig. F-10) or on the remote control (Fig. G-7) to turn OFF the Vacuum lamp (Fig. F-10).

To turn ON the vacuum fan, press the  Vacuum button on the Robotic Cleaner (Fig. F-10) or on the remote control (Fig. G-7). The lamp lights up again.

NOTICE: This setting is not possible in sleep mode with the auto-on timer activated.

NOTICE: In cases where the vacuum fan is turned OFF, the  Filter maintenance lamp (Fig. F-3) does not light even if the filter is full of dirt.

Adjusting the buzzer volume

Three levels of buzzer volume including mute can be selected.

In standby mode, repeatedly press the  Buzzer button on the Robotic Cleaner (Fig. F-9) or on the remote control (Fig. G-6). Each time you press the button, the buzzer beeps in the following order: at high volume (the lamp lights up), at low volume (the lamp lights up), and then no sound (the lamp goes off).

NOTICE: This setting is not possible in sleep mode with the auto-on timer activated.

Locating the Robotic Cleaner

This feature is useful for locating the Robotic Cleaner which may be out of sight on a large floor with desks, cabinets, and other fixtures.

Press the  Location beacon button on the remote control (Fig. G-3) while the Robotic Cleaner is in standby or sleep mode. The buzzer beeps for approx. 10 seconds and the pilot lamp flashes.





To stop the buzzer and flashing, press the  Location beacon button again.

NOTE: There may be cases where the Robotic Cleaner does not respond because the Robotic Cleaner is out of range of the remote control. The problem can be resolved by pressing the  Location beacon button while you are moving around the floor.



Using the auto-on timer



This feature enables the Robotic Cleaner to start cleaning automatically after the specified time. As the setting is cleared once the auto-timed cleaning is completed, perform the following procedure to reactivate the auto-on timer.

1. In standby mode, repeatedly press the  Timer button on the Robotic Cleaner (Fig. F-6) or on the remote control (Fig. G-5). Each time you press the button, the setting changes in the following order:

Lamp status	Cleaning starts
	after 1 hour.
	after 3 hours.
	after 5 hours.
	Auto-on timer is disengaged.

2. Press the  POWER button (Fig. F-8) on the Robotic Cleaner to activate the auto-on timer. The Robotic Cleaner enters sleep mode.

To clear the timer in standby mode, press and hold the  POWER button (Fig. F-8) on the Robotic Cleaner until all indicators go off, or press the  POWER OFF button (Fig. G-1) on the remote control.

NOTICE: If the status of both right and left battery indicators is  or , the auto-on timer may not activate and cleaning may not start automatically.

NOTICE: Changes of settings or starting of cleaning operations are not possible in this mode.

NOTICE: The auto-on timer setting is cleared if the batteries are completely discharged.

Confining the Robotic Cleaner to a particular area

Boundary tape (Fig. L-1) and the boundary-sensing feature that employs infrared sensors, enable the Robotic Cleaner to avoid the following areas (Fig. L-2):

- An area that is divided into sections because the entire floor is so large that the Robotic Cleaner cannot clean the floor at a time
- An area where fragile articles are present that the Robotic Cleaner could damage
- An area full of goods and fixtures, barriers, or of an intricate shape, resulting in the Robotic Cleaner getting stuck
- An area in the vicinity of a staircase
- An area with a low barrier that the Robotic Cleaner can climb over and fall down to a lower floor, or that the Robotic Cleaner will get stuck on

Preparations

1. Select an even and smooth surface on the floor where you plan to place the boundary tape, and then clean the surface.
2. Place the boundary tape so that the side with the short bars is adjacent to the cleaning area and there are no air bubbles between the tape and the floor.

NOTICE: Be sure to use only genuine boundary tape. Using a tape other than the genuine article might risk malfunctioning of the boundary-sensing feature.

NOTICE: Do not place the boundary tape on uneven surfaces that may cause erroneous detection or on surfaces where the tape may become soiled or damaged.

NOTICE: Be aware that some adhesive agent may remain on floors, or the floor may be damaged when you remove the boundary tape.

NOTICE: Keep the boundary tapes clean and check if any positions torn or ripped. If the tape is damaged, replace it.

WARNING: Do not place the boundary tape in any area where an accident occurs resulting from the Robotic Cleaner entering the area or the Robotic Cleaner falling down from the area. In such a case, place objects whose height is 15 cm or higher and that are heavy enough to withstand the impact of the Robotic Cleaner, in place of the boundary tapes.

Operations

In standby mode, press the  Boundary sensor button (Fig. F-11) on the Robotic Cleaner to activate the boundary sensor (Fig. O-2).

The lamp (Fig. F-11) lights up.

To deactivate the boundary sensor, press the  Boundary sensor button again.

NOTICE: This setting is not possible in sleep mode with the auto-on timer activated.

MAINTENANCE

⚠ CAUTION: Always make sure that both battery cartridges are removed before attempting to perform inspection or maintenance.

NOTICE: Be sure to take out the dust box before turning over the Robotic Cleaner to prevent dust and dirt from dropping out of the main brush opening.

NOTICE: Be sure to spread a rug or other cushioning material on the floor to prevent damage to the floor and the Robotic Cleaner (Fig. B).

NOTICE: Never use hot water (higher than 40°C (104°F)), gasoline, benzine, thinner, alcohol or the like. Discoloration, deformation, or cracks may result.

To maintain product SAFETY and RELIABILITY, repairs, any other maintenance, or adjustment should be performed by Makita Authorized or Factory Service Centers, always using Makita replacement parts.

Cleaning the side brushes (Figs. A, M-1)

- Threads and hairs tangled in the bristles of the side brushes may cause the brush to stop rotating. Remove them using tweezers or similar tools.
- If the bristles are deformed or missing, replace with the spare brush (see "Installing the side brushes" for details).

Cleaning the wheels

- Remove threads and hairs from the drive wheels (Fig. M-2) using tools such as tweezers and scissors. Turning the wheel facilitates the cleaning.
- Remove threads and hairs from the swivel wheels (Fig. M-3) using tweezers, scissors, or similar tools.

NOTICE: Care must be taken so that fingers are not caught between the wheels and the Robotic Cleaner body.

Cleaning the main brush

Removing the side brushes (see "Installing the side brushes" for details) facilitates the following work.

1. Remove four screws (Fig. N-1), and then the bottom plate (Fig. N-2) and main brush (Fig. N-3).
2. Wipe the bottom plate (Fig. N-2) with a cloth slightly moistened with mild detergent or wash the plate in water if necessary.
3. Remove threads and hairs from the main brush (Fig. N-3) using scissors and wash the main brush in water if necessary.

4. Wipe the inside of the vacuum vent (Fig. N-4) with a cloth slightly moistened with mild detergent.
5. To replace the main brush, align the protruding portion (Fig. N-5) on the right end of the main brush with the indentation on the right shaft bush (Fig. N-6), and then insert the main brush to join them together.
6. Insert the left square end of the main brush (Fig. N-7) into the left square shaft bush (Fig. N-8).
7. Replace the bottom plate in the reverse sequence.

NOTE: When the side brushes remain attached to the body of the Robotic Cleaner, manually rotating the side brush facilitates attachment of the bottom plate without pinching the bristles of the side brushes between the plate and body of the Robotic Cleaner.

Cleaning the sensors

- Clean the cliff sensors (Fig. O-1) and boundary sensors (Fig. O-2) using a clean, dry cotton applicator.
- Clean the ultrasonic sensors (Fig. P-1) using another vacuum cleaner set in gentle suction mode. A total of 8 sensors are located on the front and both sides of the bumper (Fig. P-2).

Cleaning the filter and dust box

NOTICE: To avoid damaging the upper dust box lid, do not open or close it forcibly.

1. Undo both locks (Fig. Q-1) and lift the upper dust box lid while holding the  Filter maintenance mark (Fig. Q-2) to open the filter compartment.
2. Take out the filter (Fig. Q-3) and tap it against the garbage bag or on a waste sheet spread on an even surface to shake off the dust and dirt.

NOTICE: Do not scrub or squash the filter, nor use a pointed object to clean the filter.

3. Wash the filter if the suction power of the Robotic Cleaner becomes weak.

NOTICE: If the filter smells, soak the filter in a diluted solution of household bleach (10 milliliters of bleach per 1 liter of water) for approx. 3 hours before washing the filter in running water.

4. Wash the dust box.
5. Dry the filter (if you have washed it) and the dust box for 1 day in a well-ventilated place to prevent unpleasant odor or malfunctions.

NOTICE: Do not dry the wet filter using a hair dryer or other heat source.

6. Replace the filter in the dust box in the reverse sequence.







NOTICE: When you replace the filter in the compartment, make sure that the tabs (Fig. Q-4) on the filter are fitted to the cut in the edge of the filter holder (Fig. Q-5).



Cleaning the body

1. Wipe the Robotic Cleaner's exterior with a cloth slightly moistened with mild detergent.
2. Press and release the top lid (Fig. K-1) to unlock, and then fully open the lid.
3. Take out the dust box (Fig. K-2).
4. Wipe the Robotic Cleaner's interior (Fig. R-1) including the vent grill (Fig. R-2) with a cloth slightly moistened with mild detergent.

RESTORING THE ROBOTIC CLEANER

















When the Robotic Cleaner cannot continue to operate under such conditions as drive wheel hanging down or running out of battery power, the Robotic Cleaner will stop cleaning and tell you something is wrong by the following lamps and buzzers.



-  Troubleshooting lamp (Fig. F-2)
-  Filter maintenance lamp (Fig. F-3)
-  Brush maintenance lamp (Fig. F-4)
-  Timer lamps (Fig. F-6)
-  Buzzer lamp (Fig. F-9)
-  Vacuum lamp (Fig. F-10)
-  Boundary sensor lamp (Fig. F-11)

1. Identify the problem using the following table.
2. Resolve the problem.
3. Press the  POWER button (Fig. F-8) on the Robotic Cleaner or the  Start/Stop button (Fig. G-2) on the remote control to enter standby mode. The error indication stops and the Robotic Cleaner is ready for cleaning.

NOTICE: If the error occurs again, turn OFF and ON the Robotic Cleaner.









NOTICE: If the problem persists after the remedial action is complete, consult your nearest Makita Service Center.

 lamp flashes 4 times for each sequence	<ul style="list-style-type: none"> • Threads and hairs are tangled with the drive wheels. ➔ Remove them from the drive wheels (Fig. M-2). • The Robotic Cleaner passed through a confined area where its top surface was pushed down. ➔ This is not a malfunction.
 lamp flashes 5 or 7 times for each sequence	<ul style="list-style-type: none"> • The Robotic Cleaner has overheated. ➔ Turn the Robotic Cleaner OFF, remove the battery cartridge(s), and wait for an hour. Use the Robotic Cleaner only at room temperatures not exceeding 40°C (104°F).
 and  lamps flash once for each sequence	<ul style="list-style-type: none"> • The dust box or the filter has not been installed. ➔ Install the dust box or the filter.
 and all  lamps flash once for each sequence	<ul style="list-style-type: none"> • The remaining battery charge was not enough ( or ) to start cleaning. ➔ Fully charge the battery cartridges.
 and  lamps light up	<ul style="list-style-type: none"> • Threads and hairs are tangled in the drive wheels. ➔ Remove them from the drive wheels (Fig. M-2). • The Robotic Cleaner passed through a confined area where its top surface was pushed down. ➔ This is not a malfunction.
 and  lamps light up	<ul style="list-style-type: none"> • A sensor error has occurred. ➔ Turn the Robotic Cleaner OFF and then ON.
 and  lamps light up	<ul style="list-style-type: none"> • An error has occurred in the Robotic Cleaner. ➔ Turn the Robotic Cleaner OFF and then ON.
 lamp flashes once for each sequence	<ul style="list-style-type: none"> • Threads and hairs are tangled in the side brushes and main brush. ➔ Remove them from the brushes (Figs. A, N-3).
 lamp lights up	<ul style="list-style-type: none"> • The dust box is full of dust and dirt or the filter is clogged. ➔ Empty the dust box (Fig. K-2) and clean the filter (Fig. K-5).

Indication	Cause/Remedy
 lamp flashes once, twice, or 6 times for each sequence	<ul style="list-style-type: none"> • The drive wheel is hanging down. • The Robotic Cleaner has gotten stuck on a barrier. • The Robotic Cleaner has been exposed to direct sunlight. • The Robotic Cleaner has stopped on a black floor. ➔ Move the Robotic Cleaner away from the area. ➔ If the error occurs again, clean the cliff sensors (Fig. O-1).
 lamp flashes 3 times for each sequence	<ul style="list-style-type: none"> • A bumper sensor error has occurred. ➔ Push the bumper (Fig. P-2) 10 times.

TROUBLESHOOTING

NOTE: If the problem persists after the remedial action is taken, consult your nearest Makita Service Center.

Symptom	Cause/Remedy
The lamps do not light up when you press the  button. The Robotic Cleaner does not operate when you press the button on the Robotic Cleaner or the remote control.	<ul style="list-style-type: none"> ➔ Install the battery cartridges correctly. ➔ Fully charge the battery cartridges. ➔ Press the  button to turn the Robotic Cleaner ON.
The Robotic Cleaner does not operate.	<ul style="list-style-type: none"> ➔ If the  Troubleshooting lamp,  Filter maintenance lamp, or  Brush maintenance lamp lights up or flashes, see "RESTORING THE ROBOTIC CLEANER" to resolve the problem. ➔ If the pilot lamp flashes slowly, press and hold the  POWER button on the Robotic Cleaner until all indicators go off, or press the  POWER OFF button on the remote control to clear the timer.
The Robotic Cleaner starts operation automatically.	<ul style="list-style-type: none"> • The auto-on timer has been activated.
The Robotic Cleaner stops operation during cleaning.	<ul style="list-style-type: none"> ➔ Turn the Robotic Cleaner OFF, and then remove any cords, strings, etc. from the drive wheels. ➔ If the Robotic Cleaner has gotten stuck on a barrier or other obstacle, move the Robotic Cleaner to a different location.
The cruising speed is not constant.	<ul style="list-style-type: none"> • If an obstacle is detected, the Robotic Cleaner will slow down as it takes time to calculate a traveling direction. This is not a malfunction of the Robotic Cleaner.
The Robotic Cleaner does not travel straight forward.	<ul style="list-style-type: none"> ➔ Turn the Robotic Cleaner OFF, and then remove any foreign objects tangled in the drive wheels. ➔ Clean the ultrasonic sensors.
The Robotic Cleaner is hitting obstacles more frequently than before.	<ul style="list-style-type: none"> ➔ Clean the ultrasonic sensors.
The Robotic Cleaner falls down stairs or to a lower floor.	<ul style="list-style-type: none"> ➔ Clean the cliff sensors. • The Robotic Cleaner may not avoid differences in level of 5.5 cm or less. This is not a malfunction of the Robotic Cleaner.
The operating sound is louder than usual.	<ul style="list-style-type: none"> ➔ Empty the dust box and clean the filter, the side brushes, and the main brush.
The suction power is not strong enough to capture dust and dirt.	<ul style="list-style-type: none"> ➔ Empty the dust box and clean the filter. ➔ Press the  Vacuum button on the Robotic Cleaner or on the remote control to turn ON the vacuum fan.

The side brushes fall off.	➔ Install the side brushes correctly (Fig. A).
The side brushes do not rotate or rotate with difficulty.	<ul style="list-style-type: none"> ➔ Clean the side brushes and the main brush. ➔ Install the main brush and the plate correctly (Fig. N).
The exhaust air smells.	➔ Empty the dust box and clean the filter.
The remote control does not work.	<ul style="list-style-type: none"> ➔ Install the remote control batteries correctly (Fig. E). ➔ Replace the batteries with new ones. ➔ Press the  POWER button on the Robotic Cleaner to turn it ON. ➔ Move closer to the Robotic Cleaner or remove obstacles between the Robotic Cleaner and the remote control. ➔ Stop using the Robotic Cleaner near or move it away from equipment that uses radio frequencies in the 2.4 GHz band (kitchen microwaves, Bluetooth devices, Wi-Fi devices, etc.). ➔ Turn the Robotic Cleaner OFF and then ON.
The auto-on timer does not work.	<ul style="list-style-type: none"> ➔ Use fully charged battery cartridges. ➔ Reactivate the auto-on timer.

OPTIONAL ACCESSORIES

 CAUTION: These accessories or attachments are recommended for use with your Makita tool specified in this manual. The use of any other accessories or attachments might present a risk of injury to persons. Only use the accessory or attachment for its stated purpose.

- Boundary tape
- Side brush
- Main brush
- Bottom plate
- Filter
- Makita genuine battery and charger

NOTE: Some items in the list may be included in the tool package as standard accessories. They may differ from country to country.

REFERENCE INFORMATION

Makita Corporation and its subsidiaries, affiliates, and distributors may use Usage Information for the purpose of after-sales services such as maintenance and repair. Usage Information consists of number of operations, distribution load, error information, operational status, and/or maintenance record of the power tool.

Complies with
IDA Standards
DA107248

简体中文（原版说明书）

警告：本机不可让身心或感官功能不健全或缺乏经验和知识的人（包括小孩）使用。应该监管小孩以确保其不会玩耍本机。

目次

目次	18
规格	18
安全警告	19
按钮和指示灯	21
使用之前	22
操作	23
维护	27
恢复扫地机器人	28
故障排除	29
选购附件	30
参考信息	30

规格

标准电池	BL1815N、BL1820B、 BL1830B、BL1840B、 BL1850B、BL1860B
电池使用时间 (使用选购的锂离子 电池)	使用两个BL1830 (各18V、3Ah) 时约120分钟
	使用两个BL1850 (各18V、5Ah) 时约200分钟
尘盒容量	2.5 L
尺寸 (宽/长/高) (包含 BL1830 电池)	约460 x 460 x 180 mm
重量 (包含两 块BL1830 电池)	约7.8 kg

- 这里的规格如因我们的持续研发计划而有变更，恕不另行通知。
- 规格可能因国家而异。

符号



阅读使用说明书。



不要踩或放物体到扫地机器人上面。



不要在明火或易燃和/或危险材料附近使用扫地机器人。



如果底部的悬崖传感器脏或湿，请清洁它们。

用途

这是款用于清洁室内地板的扫地机器人。遥控器通过无线(2.4 GHz ZigBee)连接扫地机器人。

安全警告

警告

不要在易燃物附近使用扫地机器人或吸掉易燃物。

这可能引起爆炸或火灾。

- 煤油、汽油、香、蜡烛
- 挥发油、稀释剂
- 烟蒂
- 色粉或其他易燃物
- 地毯清洁剂或其他泡沫物质

不要在湿的地方、可能会变湿的地方或高温高湿的地方使用扫地机器人。另外，不要吸水。

这可能导致触电、短路、火灾、变形或故障。

- 在用水的厨房和其他区域
- 浴室
- 沐浴间
- 阁楼等

不要用湿手接触扫地机器人。

这可能导致触电。

不要在炉子或其他加热设备周围使用扫地机器人。

这可能导致触电、短路、火灾、变形或故障。

不要在以下类型的地方使用扫地机器人。

这可能导致触电或伤害。

- 在婴儿或身心或感官功能不健全或缺乏必要的经验和知识的人附近
- 在动物附近
- 在人多或交通量大的地方附近

不要让没有监管的小孩或不能表达其意志的人或自己不能操作扫地机器人的人使用扫地机器人。

这可能导致触电或伤害。

在下列异常或故障的情况下请立即停止操作。

不遵守此指南可能导致冒烟、火灾或触电。

- 即使开启扫地机器人，它也不能工作。
- 扫地机器人变形或异常热。
- 扫地机器人在工作中有时会停止。
- 扫地机器人在工作中发出异常噪声。
- 扫地机器人发出烧焦的味道。

在禁止使用的地方请关闭扫地机器人。

不遵守此指南可能导致医疗设备操作失常。当在医疗机构内使用会发出无线电波的设备时，确保遵循各医疗机构的指南。

不要在狭窄且没有包围的高处使用扫地机器人。

这可能导致扫地机器人从高处掉下，导致受伤或故障。

- 楼梯
- 在桌子、搁板、梳妆台、冰箱等上面
- 夹楼层、顶楼、直接降下到楼梯或门口的楼面等
- 倾斜10度或以上的地方

不要将扫地机器人暴露在直射阳光或红外线下。

因传感器错误导致的异常操作可能导致扫地机器人掉落，造成伤害或故障。

- 卤素加热器
- 遥控或传感器等
- 透过霜花玻璃射入的阳光

移动任何如果与扫地机器人接触可能导致事故的物体。

不遵循此指南可能因物体倾倒或掉落而造成伤害。

- 点着的蜡烛、花瓶等
- 控件与扫地机器人处在相同高度的电子装置。

不要盖住扫地机器人。

这可能因过热而造成火灾。

不要骑坐或放置重物在扫地机器人上面。不要施加强烈的物理冲击。

这可能造成伤害、损坏或故障。

特别要留意扫地机器人附近的小孩。

切勿修改扫地机器人。

这可能造成火灾、触电或伤害。

修理请咨询购买扫地机器人的经销商。

不要阻塞或插入金属或易燃异物到吸入或排出口。另外，不要在可能阻挡吸入口的物体周围使用扫地机器人。

这可能导致触电、火灾或故障。

不要加热或让扫地机器人暴露到火或让其留在热的地方，例如火或炉子附近、暴露在直射阳光下或留在骄阳下的车子中。

这可能造成短路、火灾或导致电池漏液或爆炸。

不要水洗或让扫地机器人*暴露到水或洗涤剂。

这可能导致触电、短路或火灾。

* 不包含主刷、底盘、侧刷、尘盒和过滤器

运作中不要接触驱动轮或将手或脚插到扫地机器人下面。

这可能导致伤害。

特别要留意扫地机器人附近的小孩。

不要阻挡或将异物插入扫地机器人的传感器中。

这可能导致操作失灵、因操作不正确导致扫地机器人掉落而造成伤害，或故障。

不要粘胶带到传感器或轮子。不要改变缓冲器或轮子形状或用力按压缓冲器。

这可能导致操作失灵、因操作不正确导致扫地机器人掉落而造成伤害，或故障。

定期清洁各传感器。

不遵循此指南可能导致操作失灵、因操作不正确导致扫地机器人掉落而造成伤害，或故障。

不要使用脏、撕裂或破损的边界带（另售）。

这可能因操作失灵造成扫地机器人掉落而造成伤害。

▲ 注意

不要在以下地方使用扫地机器人。

这可能导致其他设备操作不正常。

- 在医院内或医疗设备附近
- 在飞机内
- 在需要精确控制或使用微弱信号的设备附近

确保使扫地机器人和遥控器距离可植入心脏起搏器和除颤器15厘米以上。

不遵守此指南可能导致医疗设备失灵。

不要将异物插入空隙和开口中。

这可能导致触电或伤害。

在清洁扫地机器人时，小心不要夹到手指。

这可能导致伤害。

在使用扫地机器人之前，务必读完此使用说明书。

不遵守此指南可能导致伤害或故障。

注意

如果察觉有异味、电池泄漏、异常发热、变形或变色，立即停止使用电池。

不遵守此指南可能导致故障。

不要在室外或在可能转到室外的地方使用扫地机器人。

这可能导致故障。

不要在以下地方使用扫地机器人。

这可能导致故障。

- 在有油烟或其他油类飘浮在空气中的地方
- 在使用喷雾剂或化学产品的地方，例如理发店、美容院和干洗店
- 多尘的地方

不要在以下地方使用扫地机器人。

这可能损坏地板覆盖物或刮花地板。

- 有容易损坏的地板覆盖物（羊皮、毛毡材料等）的地方
- 未打磨的木制或大理石地板
- 刚上蜡的地板

不要在长绒（7毫米以上）地板覆盖物上使用扫地机器人。

这可能导致地板覆盖物损坏或造成扫地机器人故障。

不要在混凝土地板等硬而不平整的表面上使用扫地机器人。

这可能增加刷子和轮子的磨损。

不要使用刷子或轮子破损的扫地机器人。

这可能造成地板刮花。

请停止操作并咨询购买扫地机器人的经销商。

去除沾在主刷、侧刷和轮子上的任何砂土。

不遵守此指南可能导致地板乱花。

不要吸以下东西。

这可能在扫地机器人内部造成刮擦或阻塞，或导致故障。

- 液体或湿的垃圾
- 化学物质或油
- 宠物排泄物
- 大量沙子或粉末
- 锋利物体（玻璃、刀片、针等）
- 大的纸或塑料垃圾
- 线或绳子

在吸完细粉末（灰泥、水泥、粉笔末等）之后清洁过滤器。

不遵守此指南可能导致故障。

不要使用过滤器堵塞或传感器脏的扫地机器人。

这可能导致故障。

不要给旋转的刷子或其他移动部件上油。

这可能导致塑料裂开。

保管使用说明书。

电池工具的使用和保养

1. 仅用制造商指定的充电器充电。适合一种类型电池的充电器被用于另一种电池时，可能构成火灾危险。
2. 仅用特别指定的电池使用电动工具。使用任何其他电池可能构成伤害或火灾危险。
3. 不使用电池时，不要与会接通一个端子到另一个端子的回形针、硬币、钥匙、铁钉、螺丝或其他金属物放在一起。
4. 在极端情况下，电池可能会冒出液体；请避免接触。如果意外发生接触，请用热水冲洗。

电池重要安全指南

1. 在使用电池之前，请阅读(1)电池充电器、(2)电池和(3)使用电池的产品上面的所有指南和注意标记。
2. 不要拆解电池。
3. 如果操作时间变得比平时明显短，请立即停止操作。否则可能导致过热、燃烧甚至爆炸的危险。
4. 如果电解液进入眼睛，请立即用清水冲洗掉并就医。否则可能导致失明。
5. 不要使电池短路：
 - (1) 不要用任何导电材料接触端子。
 - (2) 避免将电池与铁钉、硬币等其他金属物存放在一个容器中。
 - (3) 不要使电池暴露于雨水中。电池短路会导致大电流、过热、燃烧甚至分解。
6. 不要将扫地机器人和电池存放在温度可能会达到或超过50°C的任何地方。
7. 不要焚烧电池，即使它严重损坏或完全破损。电池在火中会爆炸。

8. 小心不要掉落或击打电池。

9. 不要使用损坏的电池。

10. 请遵循与电池废弃相关的本地规定。

保管使用说明书。

▲注意：只使用正宗牧田电池。使用非正宗牧田电池或更改过的电池可能造成电池爆裂而导致火灾、人身伤害和损失。它还将使牧田工具和充电器的牧田保修失效。

保持最长电池寿命的提示

1. 在电池放完电之前给电池充电。当您注意到工具动力不足时，务必停止操作并给电池充电。
2. 切勿给充满电的电池再充电。过度充电会缩短电池使用寿命。
3. 请在10°C - 40°C的室温范围内给电池充电。在给热的电池充电之前先让其冷却。
4. 在长期（超过六个月）存放之前，建议您给电池充电。

工具/电池保护系统

扫地机器人备有工具/电池保护系统，它可自动切断到电机的电力以延长扫地机器人和电池的使用寿命。在下列情况时，扫地机器人将自动停止。

过负荷

当扫地机器人过负荷抽取异常大的电流时，扫地机器人将不给任何指示就自动停止。要重新启动扫地机器人，关闭电源，消除过负荷的原因，然后重新开启电源。

过热

当扫地机器人过热时，灯每序列闪烁5或7次，然后自动停止。在此情况下，让扫地机器人冷却下来再重新开启电源。











过放电

当剩余电池电量变低时，扫地机器人将自动停止，并且不响应任何开关操作。在此情况下，卸下电池并给其充电。

按钮和指示灯

您可通过搜索此文档中对应各部件的图号来找到部件的详细信息（例如，搜索“图F-8”查找电源按钮）。

扫地机器人（图F）

1. 信号灯
2.  故障排查灯
3.  过滤器维护灯
4.  刷子维护灯
5.  电池指示灯（用于右侧和左侧电池）
6.  定时器按钮和灯
7.  巡航模式按钮和灯
□ : 样式模式
⊗ : 随机模式
8.  电源（启动/停止）按钮
9.  蜂鸣器按钮和灯
10.  吸尘按钮和灯
11.  边界传感器按钮和灯

遥控器（图G）

1.  关机按钮
2.  启动/停止按钮
3.  位置灯标按钮
4. □ / ⊗ 巡航模式按钮
5.  定时器按钮
6.  蜂鸣器按钮
7.  吸尘按钮

使用之前

装配和电池安装

注意：在扫地机器人上进行任何作业之前，务必确保关闭扫地机器人。

附带的配件

检查下列物品是否包含在包装中。

- 7号(LR03)电池 (x2)
- 侧刷 (x4, 包含两个备用刷)
- 用于侧刷安装的螺丝 (x4)
- 边界带 (15 m x1)
- 使用说明书 (x1)
- 快速开始指南 (x1)
- 使用注意事项 (x1)

安装侧刷（图A）

在扫地机器人的底部前面两侧安装侧刷。

注意：作业之前，确保在地板上铺一块厚毯或其他垫子以防损坏地板和扫地机器人（图B）。

1. 将侧刷放到扫地机器人旋转轴头，使刷子的槽嵌入轴头。
2. 用附带的螺丝紧固侧刷。

注意：确保扫地机器人装上侧刷工作。

安装电池

将电池上的槽（图C-2）对齐电池坞上的舌（图C-3）并滑入到位。请将电池插入到底直至听到小的咔哒声锁定到位。

如果您看到释放按钮上侧的红色指示（图C-1），则电池未完全锁定。

注意：安装电池时需小心，不要让手夹到坞和电池之间。

扫地机器人只需在任一个电池坞上安装一块电池就能工作。

要卸下电池，在按住上面的释放按钮（图D-1）的同时从电池坞滑出它。

在遥控器中安装电池（图E）

滑下电池舱盖，并插入两支7号（LR03）电池，注意对正极性（+/-）。





注意：不要混用新旧电池，或混用不同类型的电池。

注意：如果长时间不使用遥控器，请取出电池。

注意：如果皮肤或眼睛接触电池漏出的电解液，请立即用水冲洗。

配对扫地机器人和遥控器

扫地机器人出厂时已经与遥控器配对。但如果您更换遥控器，则必须再次进行配对。

1. 在扫地机器人上同时按住  定时器（图F-6）和  巡航模式（图F-7）按钮，直到蜂鸣器发出两次哔音。
2. 在遥控器上同时按住  定时器（图G-5）和  位置灯标（图G-3）按钮，直到蜂鸣器发出一次哔音。

如果配对失败，蜂鸣器鸣响5次，请重新进行配对。

为确保顺畅巡航

- 关闭房门。如果门槛不高，扫地机器人通过它没有问题，也可以让房门打开，这样扫地机器人可以继续打扫相邻的房间。
- 在容易损坏家具等的前面放置障碍物。
- 放置障碍物以防止扫地机器人进入可能会塞住的地方，例如在低的搁板下。
- 将高、细和不稳固的物品和其他容易翻倒的物品移到另外的房间。
- 锁定手推车或其他物品的轮子，或将其移到另外的房间。
- 沿墙壁整理好电线。
- 将垫子、书或其他可能会妨碍扫地机器人巡航的物品移到另外的房间。
- 升高下垂到地板的窗帘部分或其他东西。
- 将任何容易拉出线头或有高低差的地板覆盖物以及薄而易滑的地板覆盖物移到另外的房间。
- 将任何地板覆盖物的纓折到地板覆盖物下面。
- 拿走任何可能容易吸掉的小或贵重物品。
- 拿走任何放在地板上的绳子、皮带、线、薄纸或塑料袋。
- 缩回任何可缩地板电源插座。
- 用板子等覆盖任何格子分割的地板部分，因扫地机器人可能侦测其为边界而不通过它们。

防止扫地机器人掉落

- 如果打扫区域包含一段楼梯或其他扫地机器人可能掉落的部分，为使扫地机器人不会进入该部分，在该部分前面放置15厘米或更高并且足够重能承受扫地机器人的冲击的物体。
- 用窗帘遮挡阳光和红外线。（当扫地机器人退后以避开阳光或红外线时，可能掉落下去。）
- 关闭铝框的门。（扫地机器人可能无法侦测出铝框轨和地板之间的高低差并可能掉落到门外。）
- 将高低差相近的任何地板覆盖物移到另外的房间。（扫地机器人可能无法侦测出差别并可能掉落。）

注解

- 不要在易燃物附近使用扫地机器人或吸掉易燃物。（这可能引起爆炸或火灾。）
- 不要在湿的地方、可能会变湿的地方或高温高湿的地方使用扫地机器人。另外，不要吸水。（这可能导致触电、短路、火灾、变形或故障。）
- 不要在从墙壁到高低差处距离约1米或以下的地方使用扫地机器人。（在极少数情况下，扫地机器人可能在退后时掉落。）
- 不要在扫地机器人不能爬过的屏障位于墙壁或障碍物附近的地方使用扫地机器人。扫地机器人可能在退后以避开墙壁或障碍物的时候卡在屏障上。
- 解除任何家庭安全系统等。（扫地机器人可能被错误地检测为入侵者。）
- 扫地机器人可能不会避开水平差5.5厘米或以下。
- 工作中电视屏幕上可能出现杂讯。（这不是电视机的故障。）
- 不要长时间搁置装有电池的扫地机器人。（电池可能泄漏电解液。）
- 不要将装有电池的扫地机器人倒置。（可能会压下按钮，导致意外动作。）

操作

扫地机器人根据预设的巡航模式在地板上巡航，使用超声波传感器（图P-1）避开障碍物，并使用侧刷、主刷和吸尘风扇在途经的地方捕获灰尘、脏物和其他碎屑。但传感器在某些情况下可能无法侦测到障碍物。如果扫地机器人撞到障碍物，其缓冲器（图P-2）会吸收冲击力并改变行进方向。

注解：虽然扫地机器人设计为能够越过1.5厘米高度的屏障，有些情况下也可能过不去。

注解：扫地机器人可能会避开黑色、有黑色木纹图案的区域或玻璃制作的区域。

注解：在完成一个打扫周期之后，在某些情况下可能会留下一些灰尘和脏物。

注解：在下列情况下，无线通讯可能被打断或阻挡。







- 在用钢筋混凝土或金属建筑材料构建的建筑物内
- 当扫地机器人在障碍物后面时
- 在使用相同频段的无线电通讯设备附近
- 在产生电磁场（微波炉等）或静电的设备或造成无线电波干扰的设备附近

基本操作

▲注意：在调整或检查扫地机器人上的任何功能之前，务必确保扫地机器人关闭。



注意：如果发生结露，关闭扫地机器人并等到扫地机器人变干再重新开始工作。

注意：当扫地机器人关闭时，所有设定都不会清除。务必通过扫地机器人上的灯（图F-6、7、9、11）来确认设定正确，以防意外操作。

1. 按扫地机器人上的  电源按钮（图F-8）。
扫地机器人进入待机模式，并且  电池指示灯（图F-5）亮起。（有关详情，参见下面的“扫地机器人上的电池指示灯”。）
2. 重复按扫地机器人上的  巡航模式按钮（图F-7）选择模式，或按遥控器上的  或  巡航模式按钮（图G-4）。所选模式的灯亮起。（有关详情，参见下面的“巡航模式”。）
3. 按扫地机器人上的  电源按钮（图F-8）或遥控器上的  启动/停止按钮（图G-2）开始打扫。
在打扫中，信号灯（图F-1）将闪烁并且蜂鸣器发出哔音。

要暂停打扫，再次执行步骤3。

要恢复打扫，再次执行步骤3。



要关闭扫地机器人，按住扫地机器人上的  电源按钮（图F-8）直到所有指示灯熄灭，或按遥控器上的  关闭电源按钮（图G-1）。

▲注意：不要凑近看信号灯光，或避免让灯光进入您的眼睛。这样做可能会损害您的眼睛。

扫地机器人上的电池指示灯

位于对应电池侧的电池指示灯亮起并指示电池的剩余电量。

注意：下表提供了剩余电池电量的粗略指示。剩余电量可能根据使用情况和室温而异。







	50%或更多
	20%到50%之间
	20%或更少
	空/未安装电池
	电池错误

电池上的电池指示灯

在以字母“B”结尾的型号的电池上也可以使用电池指示灯（图I-1）检查剩余电量。

卸下电池并按  按钮（图I-2）。

注意：下表提供了剩余电池电量的粗略指示。剩余电量可能根据使用情况和室温而异。

	75%或更多
	50%到75% （包括50%）
	25%到50%之间
	25%或更少
	空
	电池错误

巡航模式

□ 样式模式	应用： 障碍物较少的大地板，例如在整理有序的仓库和长廊中。 描述（图H-1）： 扫地机器人重复一个纵向(a)和横向(b)的行程周期。*
▣ 随机模式	应用： 有许多障碍物的地板，例如在办公室中。 描述（图H-2）： 扫地机器人重复一个弹回(c)和沿墙(d)的行程周期。

* 取决于遇到的情况，扫地机器人的实际路径可能与此图形有差别。

注解：扫地机器人不能打扫它不能通行或侧刷不能达到的狭窄区域。

注解：在打扫周期结束之后，在某些情况下地板上可能留下一些灰尘。

睡眠模式

如果留置扫地机器人在待机模式中约5分钟，扫地机器人将自动进入睡眠模式以节省电池，并且信号灯（图F-1）慢速闪烁。当启用自动开启定时器时，扫地机器人也会进入睡眠模式。要回到待机模式，执行“基本操作”中的步骤3。

注意：在此模式下不可以改变设定和开始打扫操作。

携带扫地机器人

▲注意：在携带扫地机器人之前，确保关闭扫地机器人。

▲注意：小心不要让手夹在把手和扫地机器人机身之间。



抓住把手（图J-1）。

注意：如果您用另一只手支撑扫地机器人的后底部，小心不要抬起该侧太多，否则扫地机器人中的灰尘和脏物会掉出主刷开口。

注意：不要拖扫地机器人。

倒空尘盒

每次使用之后倒空尘盒，以保持扫地机器人在最高性能工作。

1. 按住扫地机器人上的  电源按钮（图F-8）直到所有指示灯熄灭，或按遥控器上的  关闭电源按钮（图G-1）关闭扫地机器人。
2. 按下并释放顶盖（图K-1）以将其解锁，然后完全打开盖子。
3. 取出尘盒（图K-2）。
4. 解除两个锁定（图K-3）并打开尘盒盖。
5. 取出并倒空上盒（图K-4）。
6. 从过滤器（图K-5）去除小的尘团并倒空下盒（图K-6）。
7. 按相反顺序装回尘盒到扫地机器人中。

高级操作

当扫地机器人在待机模式中时，可设置以下功能（参见“基本操作”中的步骤1）。

省电

扫地机器人无需使用吸尘风扇就能捕获多数可见灰尘。如果不需要除去细微灰尘，关闭吸尘风扇可节省电池电量以延长扫地机器人的工作时间。

在待机模式中，按扫地机器人（图F-10）或遥控器（图G-7）上的  吸尘按钮关闭吸尘灯（图F-10）。

要打开吸尘风扇，按扫地机器人（图F-10）或遥控器（图G-7）上的  吸尘按钮。灯将再次亮起。

注意：在启用自动开启定时器的睡眠模式中不能进行此设定。

注意：如果吸尘风扇关闭，则即使过滤器装满了脏物， 过滤器维护灯（图F-3）也不会亮起。

调节蜂鸣器音量



可选择包括静音在内的3个级别的蜂鸣器音量。

在待机模式中，重复按扫地机器人（图F-9）或遥控器（图G-6）上的  蜂鸣器按钮。每按一下按钮，蜂鸣器将按以下顺序鸣响：以高音量（灯亮起）、以低音量（灯亮起），然后不发声（灯熄灭）。

注意：在启用自动开启定时器的睡眠模式中不能进行此设定。

找出扫地机器人

在有桌子、柜子和其他固定装置的大地板上，可使用此功能来找出可能看不见的扫地机器人。

在扫地机器人处在待机或睡眠模式时，按遥控器上的  位置灯标按钮（图G-3）。蜂鸣器将鸣响约10秒钟，并且信号灯闪烁。要停止蜂鸣器和闪烁，再按一下  位置灯标按钮。

注解：如果扫地机器人不在遥控的范围之内，有时扫地机器人可能不会响应。此问题可通过在您在地板上移动的同时按  位置灯标按钮来解决。

使用自动开启定时器



此功能让扫地机器人在指定的时间之后自动开始扫地。



因一旦自动定时的打扫结束设定就会被清除，请进行以下操作以重新启用自动开启定时器。

1. 在待机模式中，重复按扫地机器人（图F-6）或遥控器（图G-5）上的  定时器按钮。每按一下按钮，将按以下顺序改变设定：

灯状态	开始打扫
	1小时之后。
	3小时之后。
	5小时之后。
	自动开启定时器解除。

2. 按扫地机器人上的  电源按钮（图F-8）启用自动开启定时器。扫地机器人进入睡眠模式。

要在待机模式中清除定时器，按住扫地机器人上的  电源按钮（图F-8）直到所有指示灯熄灭，或按遥控器上的  关闭电源按钮（图G-1）。

注意：如果左右电池指示灯的状态都是  或 ，则自动开启定时器可能不会启动，可能不会自动开始打扫。

注意：在此模式下不能改变设定或开始打扫操作。

注意：如果电池完全没电，则自动开启定时器设定将被清除。

局限扫地机器人在特定区域

边界带（图L-1）和利用红外传感器的边界感应功能可让扫地机器人避开下列区域（图L-2）：

- 分割成几个部分的区域，因为整个地板太大，扫地机器人不能一次打扫完。
- 有易碎物品的区域，扫地机器人可能造成损坏。
- 占满货物、固定装置、屏障或形状复杂的区域，这会导致扫地机器人被卡住。
- 在楼梯附近的区域。
- 有扫地机器人可以爬过并会掉落到较低地板，或会卡住的低矮屏障的区域。

准备

1. 在地板上选择要放置边界带的平整表面，然后清洁表面。
2. 放置边界带，使有短条的一侧相邻打扫区域，并且带子和地板之间没有气泡。

注意：务必只使用正宗的边界带。使用非正宗的胶带可能有边界传感器功能失灵的危险。

注意：不要将边界带置于可能导致错误误侧的不平整表面或胶带可能弄脏或损坏的表面上。

注意：注意在您取下边界带时，有些粘剂可能留在地板上，或地板可能损坏。

注意：保持边界带干净，检查任何位置是否有破损或撕裂。如果胶带损坏，请更换它。

警告：不要在因扫地机器人进入而导致事故发生的区域或扫地机器人掉落过的区域放置边界带。在这种情况下，放置重量足以承受扫地机器人冲击的15厘米或更高的物体取代边界带。

操作

在待机模式中，按扫地机器人上的  边界传感器按钮（图F-11）以启用边界传感器（图O-2）。

灯（图F-11）亮起。

要禁用边界传感器，再按一下  边界传感器按钮。

注意：在启用自动开启定时器的睡眠模式中不能进行此设定。

维护

▲注意：在进行检查或维护之前，始终确保两块电池都已卸下。

注意：在倒置扫地机器人之前，确保取出尘盒，以免灰尘和脏物掉出主刷开口。

注意：确保在地板上铺一块厚毯或其他垫子以防损坏地板和扫地机器人（图B）。

注意：切勿使用热水（高于40°C）、汽油、挥发油、稀释剂、酒精等。可能发生掉色、变形或裂开。

为维护产品安全性和可靠性，修理、任何其他维护，或调整都应由牧田授权或工厂维修中心来进行，始终使用牧田更换部件。

清洁侧刷（图A、M-1）

- 缠绕在侧刷刷毛中的线和头发可能会导致刷子停止旋转。请使用镊子或类似工具去除它们。
- 如果刷毛变形或缺失，请用备用刷子（详见“安装侧刷”）更换。

清洁轮子

- 使用镊子和剪刀等工具从驱动轮（图M-2）去除线和头发。转动轮子有助于清洁。
- 使用镊子、剪刀或类似工具从转节轮（图M-3）去除线和头发。

注意：小心不要让手夹在轮子和扫地机器人机身之间。

清洁主刷

卸下侧刷（详见“安装侧刷”）有助于以下作业。

1. 卸下四颗螺丝（图N-1），然后卸下底盘（图N-2）和主刷（图N-3）。
2. 用稍微浸湿中性洗涤液的布块擦拭底盘（图N-2），必要时用水洗。
3. 使用剪刀从主刷（图N-3）去除线和头发，必要时用水洗。
4. 用稍微浸湿中性洗涤液的布块擦拭吸尘口（图N-4）的内部。
5. 要装回主刷，将主刷右端的突起部分（图N-5）与右轴衬槽（图N-6）对齐，然后插入主刷以使其结合在一起。
6. 将主刷左方形端（图N-7）插入左方形轴衬（图N-8）。
7. 按相反顺序装回底盘。

注解：当侧刷留在扫地机器人机身时，手动转动侧刷有助于安装底盘而不会使侧刷的刷毛夹在底盘和扫地机器人机身之间。

清洁传感器

- 使用干净的棉花涂敷器清洁悬崖传感器（图O-1）和边界传感器（图O-2）。
- 使用另一个吸尘器以轻柔吸入模式清洁超声波传感器（图P-1）。在缓冲器（图P-2）的前面和两侧共有8个传感器。

清洁过滤器和尘盒

注意：为避免损坏上尘盒盖子，不要强制打开或关闭它。

1. 解锁两侧锁定（图Q-1）并在握住  过滤器维护标记（图Q-2）的同时抬起上尘盒盖以打开过滤器舱。
2. 取出过滤器（图Q-3）并在垃圾袋或铺在平坦表面的废纸上叩掉灰尘和脏物。

注意：不要刮或挤过过滤器，或使用尖头物体清洁过过滤器。

3. 如果扫地机器人的吸力变弱，请清洗过过滤器。

注意：如果过滤器有异味，将过滤器浸泡在家用漂白剂稀释溶液（每1升水兑10毫升漂白剂）中约3小时，再用水冲洗。

- 清洗尘盒。
- 在通风良好的地方阴干过滤器（如果清洗了它）和尘盒1天以免有臭味或故障。

注意：不要使用头发吹风机或其他热源吹干湿的过滤器。

- 按相反顺序装回过滤器到尘盒中。

注意：当您更换舱中的过滤器时，确保过滤器上的弹片（图Q-4）嵌到过滤器托（图Q-5）边缘的割口。



清洁机身

- 用稍微浸湿中性洗涤液的布块擦拭扫地机器人的外表面。
- 按下并释放顶盖（图K-1）以将它解锁，然后完全打开盖子。
- 取出尘盒（图K-2）。
- 用稍微浸湿中性洗涤液的布块擦拭包括通风格栅（图R-2）在内的扫地机器人的内部（图R-1）。

恢复扫地机器人













当扫地机器人遇到驱动轮垂下或电池电力用完等情况而不能继续工作时，扫地机器人将停止打扫并通过下列灯和蜂鸣器告诉您出了什么问题。

- 故障排查灯（图F-2）
- 过滤器维护灯（图F-3）
- 刷子维护灯（图F-4）
- 定时器灯（图F-6）
- 蜂鸣器灯（图F-9）
- 吸尘灯（图F-10）
- 边界传感器灯（图F-11）

- 使用下表找出问题。
- 解决问题。
- 按扫地机器人上的  电源按钮（图F-8）或遥控器上的  启动/停止按钮（图G-2）进入待机模式。
错误指示停止，扫地机器人可以打扫。

注意：如果再次发生错误，请关闭并开启扫地机器人。

注意：如果完成纠正操作之后问题还是存在，请就近咨询牧田维修中心。

指示	原因/消除方法
 灯每序列闪烁一次、两次或6次	<ul style="list-style-type: none"> 驱动轮挂下。 扫地机器人被卡在屏障上。 扫地机器人暴露在直射阳光下。 扫地机器人停止在黑色地板上。 → 从该区域移走扫地机器人。 → 如果错误再次发生，清洁悬崖传感器（图O-1）。
 灯每序列闪烁3次	<ul style="list-style-type: none"> 发生缓冲器传感器错误。 → 按缓冲器（图P-2）10次。
 灯每序列闪烁4次	<ul style="list-style-type: none"> 驱动轮缠绕了线和头发。 → 从驱动轮（图M-2）去除它们。 扫地机器人通过一局促的区域，其顶部表面压下。 → 这不是故障。
 灯每序列闪烁5或7次	<ul style="list-style-type: none"> 扫地机器人过热。 → 关闭扫地机器人，卸下电池，并等待1小时。仅在不超过40°C的室温下使用扫地机器人。
 和  灯每序列闪烁一次	<ul style="list-style-type: none"> 未安装尘盒或过滤器。 → 安装尘盒或过滤器。
 和所有  灯每序列闪烁一次	<ul style="list-style-type: none"> 剩余电池电量不足（ 或 ）以开始打扫。 → 给电池充满电。
 和  灯亮起	<ul style="list-style-type: none"> 驱动轮中缠绕了线和头发。 → 从驱动轮（图M-2）去除它们。 扫地机器人通过一局促的区域，其顶部表面压下。 → 这不是故障。
 和  灯亮起	<ul style="list-style-type: none"> 发生传感器错误。 → 关闭扫地机器人并重新开启。

△ 和 🔊 灯亮起	<ul style="list-style-type: none"> 扫地机器人中发生错误。 → 关闭扫地机器人并重新开启。
💡 灯每序列闪烁一次	<ul style="list-style-type: none"> 侧刷和主刷中缠绕了线和头发。 → 从刷子中去除它们（图A, N-3）。
☑️ 灯亮起	<ul style="list-style-type: none"> 尘盒装满了灰尘和脏物，或过滤器堵塞。 → 倒空尘盒（图K-2）并清洁过滤器（图K-5）。

故障排除

注解：如果采取纠正操作之后问题还是存在，请就近咨询牧田维修中心。

症状	原因/消除方法
按下 🔌 按钮时灯不亮起。 当您按下扫地机器人或遥控器上的按钮时，扫地机器人不工作。	<ul style="list-style-type: none"> → 正确安装电池。 → 给电池充满电。 → 按 🔌 按钮开启扫地机器人。
扫地机器人不工作。	<ul style="list-style-type: none"> → 如果 △ 故障排查灯、☑️ 过滤器维护灯或 💡 刷子维护灯亮起或闪烁，请参见“恢复扫地机器人”以解决问题。 → 如果信号灯慢速闪烁，按住扫地机器人上的 🔌 电源按钮直到所有指示灯熄灭，或按遥控器上的 ⏻ 关闭电源按钮清除定时器。
扫地机器人自动开始工作。	<ul style="list-style-type: none"> • 启用了自动开启定时器。
扫地机器人在打扫中停止工作。	<ul style="list-style-type: none"> → 关闭扫地机器人，然后从驱动轮去除任何绳、线等。 → 如果扫地机器人卡在屏障或其他障碍物上，将其移到不同的位置。

巡航速度不稳定。	<ul style="list-style-type: none"> • 如果侦测到障碍物，扫地机器人将慢下来，因为它需要时间来计算行进方向。这不是扫地机器人的故障。
扫地机器人不往前走。	<ul style="list-style-type: none"> → 关闭扫地机器人，然后从驱动轮去除缠绕的任何异物。 → 清洁超声波传感器。
扫地机器人比以往更频繁地碰上障碍物。	<ul style="list-style-type: none"> → 清洁超声波传感器。
扫地机器人掉下楼梯或掉到较低地面。	<ul style="list-style-type: none"> → 清洁悬崖传感器。 • 扫地机器人可能不会避开水平差5.5厘米或以下。这不是扫地机器人的故障。
工作声音比平时响。	<ul style="list-style-type: none"> → 倒空尘盒并清洁过滤器、侧刷和主刷。
吸力不足以捕获灰尘和脏物。	<ul style="list-style-type: none"> → 倒空尘盒并清洁过滤器。 → 按扫地机器人或遥控器上的 🌀 吸尘按钮开启吸尘风扇。
侧刷掉下。	<ul style="list-style-type: none"> → 正确安装侧刷（图A）。
侧刷不旋转或旋转困难。	<ul style="list-style-type: none"> → 清洁侧刷和主刷。 → 正确安装主刷和底盘（图N）。
出气有异味。	<ul style="list-style-type: none"> → 倒空尘盒并清洁过滤器。
遥控器不工作。	<ul style="list-style-type: none"> → 正确安装遥控器电池（图E）。 → 更换新电池。 → 按扫地机器人上的 🔌 电源按钮开启它。 → 靠扫地机器人近些，或移除扫地机器人和遥控器之间的障碍物。 → 不要在使用2.4 GHz频段的无线电频率的设备（厨房微波炉、蓝牙设备、Wi-Fi设备等）附近使用扫地机器人或将其移开。 → 关闭扫地机器人并重新开启。
自动开启定时器不工作。	<ul style="list-style-type: none"> → 使用充满电量的电池。 → 重新启用自动开启定时器。

选购附件

⚠注意：这些配件或附件推荐用于本说明书中指定的牧田工具。使用任何其他配件或附件可能构成人身伤害的危险。仅将配件或附件用于其说明的用途。

- 边界带
- 侧刷
- 主刷
- 底盘
- 过滤器
- 牧田正宗电池和充电器

注解：清单中的某些物品可能作为标准配件包含在工具包中。它们可能因国家而异。

参考信息

牧田公司及其分公司、附属公司和分销商为了维修等售后服务的目的，可能利用使用信息。使用信息包含电动工具的工作次数、分配负载、错误信息、操作状态和/或维修记录。

Complies with
IDA Standards
DA107248

产品中有害物质的名称及含量

部件名称	有害物质					
	铅 (Pb)	汞 (Hg)	镉 (Cd)	六价铬 (Cr (VI))	多溴联苯 (PBB)	多溴二苯醚 (PBDE)
印刷电路板	×	○	○	○	○	○
机壳	○	○	○	○	○	○
铁、有色金属	○	○	○	○	○	○
电动机	×	○	○	○	○	○
遥控器	×	○	○	○	○	○
配件	○	○	○	○	○	○

本表格依据SJ/T 11364的规定编制。

○：表示该有害物质在该部件所有均质材料中的含量均在GB/T 26572规定的限量要求以下。

×：表示该有害物质至少在该部件的某一均质材料中的含量超出GB/T 26572规定的限量要求。

本表中以「×」所表示的物质，属于「欧盟2011年7月RoHS指令」中指出的以现在的科学观点来看该物质的去除或替代在技术上尚未成熟且经济上无法实现。

环保使用期限：



本标志中的年数，是根据SJ/T 11364《电子电气产品有害物质限制使用标识要求》，适用于在中华人民共和国（除台湾、香港和澳门外）生产或进口的电子电气产品的“环保使用期限”。

在遵守使用说明书中记载的有关本产品安全和使用上的注意事项，且没有其他法律、规定的免责事由的情况下，在从生产日开始的上述年限内，产品中的有害物质不会发生外泄或突变，使用该产品不会对环境造成严重污染或对使用者人身、财产造成严重损害。

“环保使用期限”不是安全使用期限。尤其不同于基于电气性能安全、电磁安全等因素而被限定的使用期限。

产品在适当地使用后予以废弃时，希望依照有关电子电气产品的回收或再利用的法律或规定进行处理。

注) 该年限为“环保使用期限”，不是产品的质量保证期限。

繁體中文（原始使用說明）

警告：本機器不供身體、感官或心智能力低落或缺乏經驗與知識的人（含兒童）使用。應嚴格看管兒童，確保不讓他們玩此設備。

規格

標準電池匣	BL1815N、BL1820B、BL1830B、BL1840B、BL1850B、BL1860B
電池續航時間 (使用選購的鋰離子電池)	使用兩個 BL1830 (每個 18 V、3 Ah) 約 120 分鐘
	使用兩個 BL1850 (每個 18 V、5 Ah) 約 200 分鐘
集塵盒容量	2.5 公升
尺寸 (寬/長/高) (含 BL1830 電池)	大約 460 x 460 x 180 公釐
重量 (含兩個 BL1830 電池)	大約 7.8 公斤

- 此處所列之規格，如因我們的持續研發計畫而有所變更，恕不另行通知。
- 規格可能因國家而有所不同。

符號



請閱讀使用說明書。



切勿踩在自動掃地機器人上或放置物品在上面。



切勿在無遮蔽的火焰或可燃物/或危險物品附近使用自動掃地機器人。



如果底部的邊界感應器髒污或潮濕，請加以清潔。

用途

這是用於清潔室內地板的自動掃地機器人。遙控器與自動掃地機器人之間是透過無線連線 (2.4 GHz ZigBee)。

安全注意事項



使用自動掃地機器人時切勿靠近或吸到易燃物質，否則可能導致爆炸或起火。

- 煤油、汽油、薰香、蠟燭
- 揮發油、稀釋劑
- 煙蒂
- 碳粉或其他可燃物質
- 地毯清潔劑或其他起泡物質

切勿在潮濕場所、可能變濕的場所，或溫度與濕度高的場所使用自動掃地機器人。此外，也不可吸水，否則可能導致觸電、短路、起火、變形或故障。

- 廚房及其他會用到水的區域
- 浴室
- 淋浴間
- 閣樓等等

切勿用潮濕的手碰觸自動掃地機器人，否則可能導致觸電。

切勿在火爐或其他發熱設備附近使用自動掃地機器人，否則可能導致觸電、短路、起火、變形或故障。

切勿在以下各種場所使用自動掃地機器人，否則可能導致觸電或傷害。

- 靠近嬰兒或身體、感官或心智能力低落或缺乏必要經驗與知識的人
- 靠近動物
- 靠近大量人群或人群往來密集的区域

切勿讓無人看管的兒童或無法清楚陳述意圖或自行操作自動掃地機器人的人使用自動掃地機器人，否則可能導致觸電或傷害。

發生類似下列的異常或故障情況時，請立即停止操作。若不遵守本說明，可能導致濃煙、起火或觸電。

- 即使已開啟電源，自動掃地機器人仍沒有運轉。
- 自動掃地機器人變形或異常高溫。
- 自動掃地機器人在操作中有時會停止。
- 自動掃地機器人在操作中會發出異常雜音。
- 自動掃地機器人發出燒焦味。

在禁止使用自動掃地機器人的場所中關閉自動掃地機器人。

若不遵守本說明，可能導致醫療設備運作不正常。在醫療機構內使用會發出無線電波的設備時，務必遵守各醫療機構的指示。

切勿在狹窄與開放的高處使用自動掃地機器人。

否則可能造成自動掃地機器人從該區域掉落，導致傷害或故障。

- 階梯
- 桌面、架子、梳妝台、冰箱等家具上
- 挑高夾層、閣樓、有直通樓梯間或入口的斜面地板等
- 傾斜角度 10° 或更多的場所

切勿使自動掃地機器人直接暴露在陽光或紅外線下。感應器錯誤所造成的不當操作可能會使自動掃地機器人掉落，導致傷害或故障。

- 鹵素燈暖爐
- 遙控器或感應器等
- 透過毛玻璃進入的太陽光線

移除接觸到自動掃地機器人時可能導致事故發生的任何物品。

若不遵守本說明，可能會因物品傾倒或掉落而導致傷害。

- 點燃的蠟燭、花瓶等
- 操控裝置與自動掃地機器人位於相同高度的電器。

切勿覆蓋自動掃地機器人，否則可能因過熱而導致起火。

切勿騎乘或在自動掃地機器人上放置重物。切勿予以機體強烈震動，

否則可能導致傷害、損傷或故障。

尤其應密切留意自動掃地機器人周圍的幼童。

切勿修改自動掃地機器人，否則可能導致起火、觸電或傷害。如需維修，請洽詢您購買自動掃地機器人的經銷商。

切勿阻塞或將金屬或易燃異物放進吸氣或排氣口。此外，也不要可能在可能阻塞吸氣口的物品四周使用自動掃地機器人，否則可能導致觸電、起火或故障。

切勿加熱或使自動掃地機器人暴露在火中，或將它留在高溫場所，例如靠近火或火爐、直接曝曬在太陽光下，或放在烈日下的車輛內，否則可能導致短路、起火，或造成電池漏液或爆炸。

切勿清洗自動掃地機器人^{*} 或放在水或清潔劑中，否則可能導致觸電、短路或起火。

* 不包含主刷，底板，邊刷，集塵盒和濾網

運作過程中，切勿觸碰驅動輪或將手腳放進自動掃地機器人底下，否則可能導致傷害。尤其應密切留意自動掃地機器人周圍的幼童。

切勿阻塞或將異物放進自動掃地機器人的感應器，否則可能導致操作失敗，或因操作不當造成自動掃地機器人掉落而導致傷害，或導致故障。

切勿在感應器或輪子上貼膠帶。切勿修改緩衝器或輪形，或過度用力強壓緩衝器，否則可能導致運作失敗，或因操作不當造成自動掃地機器人掉落而導致傷害，或導致故障。

每一個感應器皆應定期清潔。

若不遵守本說明，可能導致操作失敗，或因運作不當造成自動掃地機器人掉落而導致傷害，或導致故障。

切勿使用髒污、剝落或撕裂的阻隔帶（另售），否則可能因操作失敗造成自動掃地機器人掉落而導致傷害。



注意

切勿在以下場所使用自動掃地機器人，否則可能導致其他設備操作不正常。

- 醫院內或醫療設備周圍
- 飛機內
- 需要精確控制或使用微弱訊號的電子設備周圍。

務必使自動掃地機器人和遙控器遠離植入式心律調整器和除顫器 15 公分以上。

若不遵守本說明，可能會導致醫療裝置故障。

切勿將異物放進接縫與開口，否則可能導致觸電或傷害。

清潔自動掃地機器人時，小心不要夾到手指，否則可能導致傷害。

使用自動掃地機器人之前，請仔細完整閱讀本使用說明書。

若不遵守本說明，可能導致傷害或故障。

注意

如果發現異味、電池漏液，異常高溫，變形，或變色，請立即停止使用電池匣。

若不遵守本說明，可能導致故障。

切勿在戶外或可能移動到戶外的場所使用自動掃地機器人，否則可能導致故障。

切勿在以下場所使用自動掃地機器人，否則可能導致故障。

- 空氣中懸浮著烹調油煙或其他油成分的場所

- 使用噴霧劑或化學品的場所，例如理髮店、美容美髮店及乾洗店
- 塵土飛揚的場所

切勿在以下場所使用自動掃地機器人，否則可能損傷地板鋪墊或刮傷地面。

- 地板鋪墊（羊毛、毛毯織物等）容易受損的場所
- 未完工的木質或大理石地板
- 剛打過臘的地板

切勿在地板鋪墊上有長毛的範圍（7公釐或以上）內自動掃地機器人，

否則可能導致地板鋪墊損壞或導致自動掃地機器人故障。

切勿在堅硬、凹凸不平的地面（例如水泥地板等）上使用自動掃地機器人，

否則可能導致刷子與輪子磨損增加。

如果刷子或輪子已磨損，請勿使用自動掃地機器人，否則可能導致地面刮傷。

請停止操作，並洽詢您購買自動掃地機器人的經銷商。

移除所有黏在主刷、邊刷和輪子上的沙塵。

若不遵守本說明，可能導致地面刮傷。

切勿吸入以下東西，

否則可能導致自動掃地機器人內部刮傷或堵塞，或導致故障。

- 液體或濕的垃圾
- 化學品或油類
- 寵物排泄物
- 大量沙塵或粉末
- 銳利物品（玻璃、刀片、針類等）
- 大紙張或乙炔基垃圾
- 線材或繩子

吸入細微粉末（石膏、水泥、粉筆等）後，請清潔濾網。

若不遵守本說明，可能導致故障。

如果濾網堵塞或感應器髒污，請勿使用自動掃地機器人，

否則可能導致故障。

切勿為旋轉刷子或其他活動零件上油，否則可能導致塑膠裂開。

請妥善保存這些說明。

電池工具使用與保養

1. 請僅使用製造商指定的充電器充電。適合某種類型電池組的充電器，如果用於其他電池組，可能會發生起火危險。
2. 僅限與明確指定的電池組搭配使用電力工具。使用其他任何電池組可能造成傷害或起火危險。
3. 當電池組未使用時，請遠離迴紋針、硬幣、鑰匙、鐵釘、螺絲及其他小型金屬物，因為這些物品可能會使電池電極彼此相連。
4. 在極端狀況下，可能會有液體從電池中噴出；請避免碰觸。萬一意外碰到，請用水沖洗。

電池匣的重要安全說明

1. 使用電池匣之前，請先閱讀（1）電池充電器、（2）電池及（3）使用電池的產品上的所有說明和警示標誌。
2. 切勿拆卸電池匣。
3. 如果操作時間明顯異常地變短，請立即停止操作，否則可能導致過熱危險，也可能造成燃燒，甚至爆炸。

- 如果電解液進入眼睛，請用清水沖洗出來，並立即就醫，否則可能導致視力喪失。
- 切勿使電池匣短路：
 - 切勿以任何導電物品碰觸電極。
 - 避免將電池匣放在裝有其他金屬物品（例如鐵釘、硬幣等）的容器內。
 - 切勿將電池匣暴露在水或雨中。電池短路會造成龐大電流、過熱，可能會燃燒，甚至故障。
- 切勿將自動掃地機器人和電池匣放在溫度可能達到或超過 50°C 的任何場所。
- 切勿燃燒電池匣，即使已經嚴重損壞或完全不堪使用也一樣。電池匣在火中可能會爆炸。
- 小心切勿掉落或撞擊電池匣。
- 切勿使用損壞的電池匣。
- 請遵守丟棄電池匣的相關當地法規。

請妥善保存這些說明。

注意：一律使用 Makita 原廠電池。使用非 Makita 原廠電池，或者電池經過修改，可能導致電池爆炸，造成起火、人身傷害或損傷。也會使 Makita 針對 Makita 工具與充電器的保固失效。

維持最長電池續航時間的技巧

- 在電池匣完全沒電之前就先充電。一律在發現電量較少時就停止運作並為電池匣充電。
- 已完全充電的電池匣切勿充電。過度充電會縮短電池壽命。
- 請在室溫 10°C - 40°C 的環境下為電池匣充電。請先冷卻發熱的電池匣再充電。
- 建議您在長時間收藏電池匣（超過 6 個月）之前，先為電池匣充電。

工具/電池匣保護系統

自動掃地機器人配有工具/電池匣保護系統，會自動切斷馬達電源，以延長自動掃地機器人與電池匣的壽命週期。在下列狀況下，自動掃地機器人會自動停止。

過載

當自動掃地機器人過載並造成異常高電流時，自動掃地機器人會在毫無徵兆的情況下自動停止。若要重新啟動自動掃地機器人，請先關閉電源、排除過載原因，然後再次開啟電源。

過熱

當自動掃地機器人過熱時， 指示燈會每次閃爍 5 或 7 下，且自動掃地機器人會自動停止。在此情況下，請先讓自動掃地機器人冷卻，然後再開啟電源。













過度放電

當剩餘電量變低時，自動掃地機器人會自動停止，且不會回應任何開關操作。在此情況下，請取下電池匣並充電。

按鈕與指示燈

透過搜尋本文中與每個部件相對應的圖片編號，即可找到該部件的詳細資料（例如針對  電源按鈕，搜尋「圖 F-8」）。

自動掃地機器人（圖 F）

- 導向指示燈
-  故障排除指示燈
-  濾網維護指示燈
-  刷子維護指示燈
-  電池指示燈（針對右側與左側電池匣）
-  計時器按鈕與指示燈
-  巡航模式按鈕與指示燈
 -  Z 字形模式
 -  隨機模式
-  電源（開始/停止）按鈕
-  蜂鳴器按鈕與指示燈
-  吸塵器按鈕與指示燈
-  界限感應器按鈕與指示燈

遙控器（圖 G）

-  電源關閉按鈕
-  開始/停止按鈕
-  位置信標按鈕
-  巡航模式按鈕
-  計時器按鈕
-  蜂鳴器按鈕
-  吸塵器按鈕

使用前

組裝與電池安裝

注意：為自動掃地機器人進行任何工作之前，務必確認關閉自動掃地機器人。

隨附配件

請檢查包裝中是否包含下列清單中的項目。

- AAA (LR03) 電池 (x2)
- 邊刷 (x4, 包含 2 個備用刷子)
- 邊刷安裝螺絲 (x4)
- 阻隔帶 (15 公尺 x1)
- 使用說明書 (x1)
- 快速入門指南 (x1)
- 使用注意事項 (x1)

安裝邊刷（圖 A）

在自動掃地機器人前方底部兩側安裝邊刷。

注意：執行工作之前，務必在地板上鋪毯子或其他緩衝材質，避免損傷地板和自動掃地機器人（圖 B）。

- 將邊刷放在自動掃地機器人的旋轉軸頭上，刷子溝槽安裝到軸頭上。
- 使用隨附的螺絲鎖緊邊刷。

注意：務必先確認邊刷已安裝好，才讓自動掃地機器人操作。

安裝電池匣

將電池匣的溝槽（圖 C-2）對準電池座的凸起部分（圖 C-3），然後滑入定位。將它整個插到底，直到聽到輕輕的喀嗒聲，即鎖到定位。

如果您可以看到釋放按鈕上方的紅色指示燈（圖 C-1），表示電池匣並未完全鎖定。

⚠注意：安裝電池匣時務必謹慎，避免手指被夾到電池座與電池匣之間。

自動掃地機器人僅在一個電池匣安裝在任一電池座時才會操作。

若要取下電池匣，請按住電池匣上的釋放按鈕（圖 D-1），同時將電池匣從電池座滑出。

安裝遙控器的電池（圖 E）

滑開電池盒蓋，並插入兩個 AAA（LR03）電池，請小心將電池兩極正確對準。





注意：切勿同時使用新舊電池，也不得同時使用不同類型的電池。

注意：如果遙控器長時間不使用，請取下電池。

⚠注意：如果電池漏出的電解液不慎碰到皮膚或眼睛，請立即用清水沖洗。

配對自動掃地機器人與遙控器

自動掃地機器人出廠時已經與遙控器配對完成。不過，如果更換遙控器，就必須再次執行配對程序。

1. 同時按住自動掃地機器人上的  計時器（圖 F-6）和  巡航模式（圖 F-7）按鈕，直到蜂鳴器發出兩聲嗶聲。
2. 同時按住遙控器上的  計時器（圖 G-5）和  位置信標（圖 G-3）按鈕，直到蜂鳴器發出一聲嗶聲。

如果配對失敗且蜂鳴器發出五聲嗶聲，請嘗試再次配對。

整理房間

確保巡航順暢

- 關上房門。如果門框的高度落差很小，自動掃地機器人可以通行無阻，那麼房門可以保持開啟，讓自動掃地機器人繼續清掃隔壁房間。
- 在容易損壞的家具等物品前方放置障礙物。
- 在可能讓自動掃地機器人卡住的地方（例如低貨架底下）放置障礙物，防止自動掃地機器人進入。
- 將高高細細、不平整及其他容易傾倒的物品移到其他房間。
- 將推車或其他物品的輪子鎖住，或移到其他房間。
- 整理電線使其靠牆。
- 將可能妨礙自動掃地機器人巡航的靠墊、書籍或其他物品移到其他房間。
- 將垂到地板的窗簾或其他物品的部件拉起來。
- 將容易一串串拉出的地毯或高度有落差的地板鋪墊，以及很薄且容易滑動的地板鋪墊移到其他房間。
- 將地板鋪墊流蘇折到地板鋪墊下方。
- 將所有易被吸塵器吸入的細小或昂貴物品收好。
- 將地板上的所有電線、皮帶、繩子、紙片或塑膠袋收好。
- 將所有伸縮式地板插座收好。
- 將所有格狀地板區域上木板之類的物品，因為自動掃地機器人可能會將它們偵測為邊界，而不會移動到它們上方。

防止自動掃地機器人掉落

- 如果清掃區域有一段階梯或其他自動掃地機器人可能掉落的區域，為了防止自動掃地機器人進入該區域，請在該區域前方放置高15公分或以上且重量足夠擋住自動掃地機器人碰撞的物品。

- 用窗簾擋住陽光和紅外線。（當自動掃地機器人為了避開陽光或紅外線而倒退時，可能會掉落低處。）
- 關閉鋁框落地窗門。（自動掃地機器人可能偵測不到鋁框軌道與地板之間的高度落差而跌落門外。）
- 將靠近有高度落差區域的地板鋪墊移到其他房間。（因為自動掃地機器人可能會偵測不到落差而掉落。）

注意

- 使用自動掃地機器人時切勿靠近或吸到易燃物質。（否則可能導致爆炸或起火。）
- 切勿在潮濕場所、可能變濕的場所，或溫度與濕度高的場所使用自動掃地機器人。此外，也不可吸水。（否則可能導致觸電、短路、起火、變形或故障。）
- 切勿在與牆壁高度落差距離約 1 公尺或更窄的地方使用自動掃地機器人。（在少數情況下，自動掃地機器人可能會在倒退時掉落。）
- 切勿在自動掃地機器人無法越過的阻隔物位於牆壁或者障礙物附近之區域內使用自動掃地機器人。因為自動掃地機器人在後退以避開牆壁或障礙物時可能卡在阻隔物上。
- 關閉所有居家安全系統等。（自動掃地機器人可能會被誤認為入侵者。）
- 自動掃地機器人可能無法避開 5.5 公分或更低的高度落差。
- 操作過程中，電視螢幕可能會出現雜訊。（這並非電視故障。）
- 電池匣切勿長時間安裝在自動掃地機器人上。（電池電解液可能會洩漏。）
- 在已安裝電池匣的情況下，切勿將自動掃地機器人顛倒放置。（可能會按到按鈕，導致意外操作。）

操作

自動掃地機器人會依據預設的巡航模式在地板上巡航，使用超音波感應器（圖 P-1）避開障礙物，並使用邊刷、主刷及吸塵器風扇清掃路徑上的塵土與其他碎屑。不過，在某些狀況下，感應器可能無法偵測到障礙物。如果自動掃地機器人撞到障礙物，自動掃地機器人的緩衝器（圖 P-2）會吸收衝擊並改變行進方向。

附註：即使自動掃地機器人的設計可以越過最高 1.5 公分高度的阻隔物，但是自動掃地機器人仍有可能無法越過該高度的阻隔物。

附註：自動掃地機器人可能會避開黑色、有黑色木紋圖案或以玻璃製作的區域。

附註：在某些情況下，清掃循環完成後仍可能殘留部分塵土。

附註：在下列情況下，無線通訊可能會受到干擾或阻擋：







- 以鋼筋混凝土或金屬建材建造的結構內
- 當自動掃地機器人位於障礙物後方時
- 靠近使用相同頻率波段的無線電通訊設備
- 靠近產生電磁場的裝置（微波爐等）或產生靜電的裝置，或者會導致無線電波干擾的裝置

基本操作

⚠注意：在調整或檢查自動掃地機器人的任何功能之前，務必確認自動掃地機器人的電源已關閉。



注意：如果發生露水凝結的情況，請關閉自動掃地機器人並等到它完全乾燥為止，然後再重新啟動操作。

注意：當自動掃地機器人關閉時，所有設定都不會清除。務必根據自動掃地機器人上的指示燈（圖 F-6、7、9、11）來確認設定正確，以避免意外操作。

1. 按下自動掃地機器人上的  電源按鈕（圖 F-8）。接著，自動掃地機器人會進入待機模式，而且  電池指示燈（圖 F-5）會亮起（如需詳細資料，請參閱下文「自動掃地機器人的電池指示燈」）。
2. 重複按下自動掃地機器人上的  巡航模式按鈕（圖 F-7）以選取模式，或者按下遙控器上的  或  巡航模式按鈕（圖 G-4）。所選模式的指示燈會亮起。（如需詳細資料，請參閱下文「巡航模式」。）
3. 按下自動掃地機器人上的  電源按鈕（圖 F-8）或遙控器上的  開始/停止按鈕（圖 G-2），開始清掃。
在清掃時，導向指示燈（圖 F-1）會閃爍，且蜂鳴器會發出嗶聲。

若要暫停清掃操作，請再次執行步驟 3。

若要恢復清掃操作，請再次執行步驟 3。





若要關閉自動掃地機器人，請按住自動掃地機器人上的  電源按鈕（圖 F-8），直到所有指示燈熄滅，或按下遙控器上的  電源關閉按鈕（圖 G-1）。

⚠注意：切勿近距離注視導向指示燈，並避免燈光直射眼睛，否則可能造成眼睛傷害。

自動掃地機器人上的電池指示燈

位於相對應的電池匣那一側的電池指示燈會亮起，表示電池匣的剩餘電量。

注意：下表提供電池剩餘電量的粗略估計。剩餘電量可能因使用狀況與室溫而異。







	50% 或更多
	介於 20% 與 50% 之間
	20% 或更少
	電量耗盡/未安裝電池匣
	電池錯誤

電池匣上的電池指示燈



型號尾數為字母“B”的，也可以使用電池匣上的電池指示燈（圖 I-1）來檢查剩餘電量。

取下電池匣，並按下  按鈕（圖 I-2）。

注意：下表提供電池剩餘電量的粗略估計。剩餘電量可能因使用狀況與室溫而異。

	75% 或更多
	介於 50% 與 75% 之間（含 50%）
	介於 25% 與 50% 之間
	25% 或更少
	電量耗盡
	電池錯誤

巡航模式

 Z 字形模式	適用情況： 障礙物不多的大面積地面，例如整齊的倉庫和長廊。 說明（圖 II-1）： 自動掃地機器人會重複垂直（a）與水平（b）行進方向的循環。*
 隨機模式	適用情況： 有許多障礙物的地面，例如辦公室。 說明（圖 II-2）： 自動掃地機器人會重複反彈（c）與沿著牆壁（d）行進方向的循環。

* 視碰到的狀況而定，自動掃地機器人的實際路徑可能與本圖有異。

附註：自動掃地機器人無法在不能行進的狹窄區域清掃，也無法清掃邊刷掃不到的地方。

附註：在某些情況下，清掃循環結束後，地板上仍可能殘留部分灰塵。

睡眠模式

如果自動掃地機器人在待機模式下未使用約 5 分鐘，則會自動進入睡眠模式以節省電力，而且導向指示燈（圖 F-1）會慢慢閃爍。當自動啟動計時器已啟動時，自動掃地機器人也會進入睡眠模式。
若要返回待機模式，請執行「基本操作」中的步驟 3。

注意：在此模式中，無法變更設定，也無法開始清掃作業。

搬運自動掃地機器人

⚠注意：搬運自動掃地機器人之前，務必關閉自動掃地機器人。

⚠注意：務必小心，不要讓手指被夾在把手與自動掃地機器人機身之間。



緊握把手（圖 J-1）。

注意：如果用另一隻手支撐自動掃地機器人的後面下方，務必小心不要抬太高，以免自動掃地機器人內的塵土從主刷開口掉出來。

注意：切勿拖拉自動掃地機器人。

清空集塵盒

每次使用後，請清空集塵盒，以保持自動掃地機器人的最佳效能運作狀態。

1. 按住自動掃地機器人上的  電源按鈕（圖 F-8），直到所有指示燈熄滅，或按下遙控器上的  電源關閉按鈕（圖 G-1），以關閉自動掃地機器人。
2. 按下並放開頂蓋（圖 K-1）以解開它，然後完整打開蓋子。

- 取出集塵盒 (圖 K-2)。
- 解開兩個鎖 (圖 K-3)，並打開集塵盒蓋。
- 取出並清空上層集塵盒 (圖 K-4)。
- 清除濾網上的小塊灰塵 (圖 K-5) 並清空下層集塵盒 (圖 K-6)。
- 以相反順序將集塵盒放回自動掃地機器人。

進階操作

以下功能只能在自動掃地機器人處於待機模式 (請參閱「基本操作」的步驟 1) 時設定。

省電

自動掃地機器人可在不使用吸塵器風扇的情況下清掃大部分看得見的灰塵。如果不需要清掃細微灰塵，關閉吸塵器風扇可以節省電池電力，以延長自動掃地機器人的運作時間。

在待機模式中，按下自動掃地機器人或遙控器上的  吸塵器按鈕 (圖 F-10 與圖 G-7)，可關閉吸塵器指示燈 (圖 F-10)。

若要開啟吸塵器風扇，請按下自動掃地機器人或遙控器上的  吸塵器按鈕 (圖 F-10 與圖 G-7)。指示燈會再次亮起。

注意：在自動啟動計時器已啟動的睡眠模式中，無法執行此設定。

注意：在吸塵器風扇關閉的情況下，即使濾網已塞滿塵土， 濾網維護指示燈 (圖 F-3) 也不會亮起。

調整蜂鳴器音量

蜂鳴器有三個音量等級可供選擇，包含靜音。

在待機模式中，重複按下自動掃地機器人或遙控器上的  蜂鳴器按鈕 (圖 F-9 和圖 G-6)。每次按下按鈕，蜂鳴器會以下列順序發出嗶聲：高音量 (指示燈亮起)、低音量 (指示燈亮起)，然後無聲 (指示燈熄滅)。

注意：在自動啟動計時器已啟動的睡眠模式中，無法執行此設定。

尋找自動掃地機器人

在有桌子、櫥櫃及其他固定設備的大面積地面上，自動掃地機器人可能會離開視線範圍，此功能對於找到自動掃地機器人很實用。

當自動掃地機器人處於待機或睡眠模式時，按下遙控器上的  位置信標按鈕 (圖 G-3)，蜂鳴器會發出嗶聲約 10 秒鐘，且導向指示燈會閃爍。

若要停止蜂鳴器與閃爍，請再次按下  位置信標按鈕。





附註：某些情況下，由於自動掃地機器人超出遙控器範圍，因此自動掃地機器人無法回應。在地板四周移動的同時，按下  位置信標按鈕，即可解決此問題。

使用自動啟動計時器



此功能可讓自動掃地機器人在指定時間之後自動開始清掃。



當自動定時清掃完成後，設定隨即清除，若要再次啟動自動啟動計時器，請執行以下程序。

- 在待機模式中，重複按下自動掃地機器人或遙控器上的  計時器按鈕 (圖 F-6 和圖 G-5)。每按一次按鈕，設定會依以下順序變更：

指示燈狀態	清掃開始
	1 小時後。
	3 小時後。
	5 小時後。
	自動啟動計時器解除。

- 按下自動掃地機器人上的  電源按鈕 (圖 F-8) 以啟動自動啟動計時器。自動掃地機器人會進入睡眠模式。

若要在待機模式下清除計時器，請按住自動掃地機器人上的  電源按鈕 (圖 F-8)，直到所有指示燈熄滅，或按下遙控器上的  電源關閉按鈕 (圖 G-1)。

注意：如果右側與左側電池指示燈的狀態為  或 ，自動啟動計時器可能不會啟動，而且也不會自動開始清掃。

注意：在此模式中，無法變更設定，也無法開始清掃作業。

注意：如果電池已完全沒電，自動啟動計時器設定會清除。

將自動掃地機器人設定在特定區域

阻隔帶 (圖 L-1) 和使用紅外線感應器的界限感應功能，可讓自動掃地機器人避開以下區域 (圖 L-2)：

- 劃分成數個部分的區域；由於整個地面面積太大，自動掃地機器人無法一次清掃所有地面
- 有易碎物品的區域，自動掃地機器人可能會損壞那些物品
- 放滿貨品與固定設備、阻隔物的區域，或形狀複雜的區域，會導致自動掃地機器人卡住
- 靠近樓梯的區域
- 區域內有低高度障礙物，自動掃地機器人可能會爬上去並掉落到較低地板，或者自動掃地機器人可能會卡住

準備工作

- 選擇一個您打算放置阻隔帶的平坦光滑地面，然後開始清掃表面。
- 放置阻隔帶，讓有短槓的一側毗鄰清掃區域，而且阻隔帶與地板之間沒有氣泡。

注意：務必僅使用原廠阻隔帶。使用非原廠阻隔帶可能會發生界限感應功能故障的風險。

注意：切勿將阻隔帶放在可能導致偵測錯誤的不平坦表面，或放在可能弄髒或損壞阻隔帶的表面上。

注意：當您移除阻隔帶時，小心地板上可能會殘留黏著劑，也要小心不要損壞地板。

注意：保持阻隔帶清潔，並檢查是否有任何地方撕裂或破掉。如果阻隔帶損壞，請更換。

警告：因為自動掃地機器人進入而導致意外發生的區域，或者會使自動掃地機器人掉落的區域，都不應放置阻隔帶。如果有這些區域，應放置高15公分或以上且重量足夠擋住自動掃地機器人碰撞的物品，以取代阻隔帶。

操作

在待機模式中，按下自動掃地機器人上的  界限感應器按鈕（圖 F-11）以啟動界限感應器（圖 0-2）。

指示燈（圖 F-11）會亮起。

若要關閉界限感應器，請再次按下  界限感應器按鈕。

注意：在自動啟動計時器已啟動的睡眠模式中，無法執行此設定。

保養

 注意：在嘗試執行檢查或保養之前，務必確認兩個電池匣已取下。

注意：在將自動掃地機器人倒過來之前，務必取出集塵盒，以免塵土從主刷開口掉出來。

注意：務必在地板上鋪毯子或其他緩衝材質，避免損傷地板和自動掃地機器人（圖 B）。

注意：切勿使用熱水（溫度高於 40°C）、汽油、揮發油、稀釋劑、酒精等，否則可能導致變色、變形或裂開。

為了保持產品的「安全性」與「可靠性」，所有維修、其他維護工作或調整皆應由 Makita 授權或原廠服務中心執行，而且一律使用 Makita 替換零件。

清潔邊刷（圖A、M-1）

- 邊刷刷毛上糾結的線和毛髮可能導致刷子停止旋轉。請使用鑷子或類似工具加以清除。
- 如果刷毛變形或遺失，請更換備用刷子（請參閱「安裝邊刷」以瞭解詳細資料）。

清潔輪子

- 使用鑷子與剪刀之類的工具，清除驅動輪上的線和毛髮（圖 M-2）。旋轉輪子有助於清潔。
- 使用鑷子、剪刀或類似工具，清除轉向輪上的線和毛髮（圖 M-3）。

注意：務必小心，不要讓手指被夾在輪子與自動掃地機器人機身之間。

清潔主刷

取下邊刷（請參閱「安裝邊刷」以瞭解詳細資料）有助於完成以下工作。

1. 取下四個螺絲（圖 N-1），然後取下底板（圖 N-2）和主刷（圖 N-3）。
2. 用一塊布沾少許溫水和清潔劑擦拭底板（圖 N-2），或者若有必要，可用水清洗。
3. 使用剪刀清除主刷上的線和毛髮（圖 N-3），若有必要，可用水清洗主刷。
4. 用一塊布沾少許溫水和清潔劑擦拭吸塵器排風口內部（圖 N-4）。
5. 若要更換主刷，請將主刷右側的突出部分（圖 N-5）對準右軸套管的凹口（圖 N-6），然後將主刷插入並連接在一起。
6. 將主刷左側方形（圖 N-7）插入左側方形軸套管（圖 N-8）。
7. 以相反順序將底板裝回。

附註：在邊刷仍裝在自動掃地機器人機身上的情況下，手動旋轉邊刷有助於安裝底板，而不用捏著底板與自動掃地機器人機身之間的邊刷刷毛。

清潔感應器

- 使用乾淨且乾燥的棉花棒清潔邊界感應器（圖 0-1）和界限感應器（圖 0-2）。
- 使用另一台吸塵器，以柔和吸取模式清潔超音波感應器（圖 P-1）。緩衝器前方與兩側總共有 8 個感應器（圖 P-2）。

清潔濾網和集塵盒

注意：為避免損傷上方集塵盒蓋，請勿強力開啟或關閉。

1. 解開兩個鎖扣（圖 Q-1），握住  濾網維護標記（圖 Q-2）同時抬起上方集塵盒蓋，以打開濾網隔間。
2. 取出濾網（圖 Q-3）在垃圾袋中輕敲，或在平坦表面上的廢紙上輕敲，將塵土敲掉。

注意：切勿搓洗或擠壓濾網，也不要用品銳物品清潔濾網。

3. 如果自動掃地機器人的吸力減弱，可以清洗濾網。

注意：如果濾網有異味，請用稀釋的家用漂白水溶液（每 1 公升水加 10 毫升漂白水）浸泡濾網約 3 小時，然後以流動的水沖洗濾網。

4. 清洗集塵盒。
5. 為防止異味或故障，請將濾網（如果有清洗的話）和集塵盒放在通風良好的場所 1 天，予以晾乾。

注意：濕的濾網切勿用吹風機或其他熱源使其乾燥。

6. 以相反順序將濾網放回集塵盒。







注意：更換隔間中的濾網時，請確認濾網上的垂片（圖 Q-4）對準到濾網架（圖 Q-5）的邊緣缺口。



清潔機身

1. 用一塊布沾少許溫水和清潔劑擦拭自動掃地機器人外表。
2. 按下並放開頂蓋（圖 K-1）以解開它，然後完整打開蓋子。
3. 取出集塵盒（圖 K-2）。
4. 用一塊布沾少許溫水和清潔劑擦拭自動掃地機器人內部（圖 R-1），包括排風口網格（圖 R-2）。

修復自動掃地機器人



















如果自動掃地機器人因為驅動輪下垂或電池沒電之類的情況而無法繼續操作，自動掃地機器人會停止清掃，並透過以下指示燈和蜂鳴器提醒您發生問題了。

-  故障排除指示燈（圖 F-2）
-  濾網維護指示燈（圖 F-3）
-  刷子維護指示燈（圖 F-4）
-  計時器指示燈（圖 F-6）
-  蜂鳴器指示燈（圖 F-9）
-  吸塵器指示燈（圖 F-10）
-  界限感應器指示燈（圖 F-11）

1. 請使用下表確認問題所在。
2. 解決問題。
3. 按下自動掃地機器人上的  電源按鈕 (圖 F-8) 或遙控器上的  開始/停止按鈕 (圖 G-2), 以進入待機模式。
錯誤指示已停止, 且自動掃地機器人準備就緒, 可以開始清掃。















注意: 如果再次發生錯誤, 請關閉並開啟自動掃地機器人。

注意: 如果修復動作完成後, 問題依然存在, 請洽詢您最近的 Makita 服務中心。

指示	原因/解決方法
 指示燈每個次閃爍 1 下、2 下或 6 下	<ul style="list-style-type: none"> • 驅動輪下垂。 • 自動掃地機器人卡在阻隔物上。 • 自動掃地機器人直接曝曬在太陽光下。 • 自動掃地機器人停在黑色地板上。 <p>→ 將自動掃地機器人移出該區域。 → 如果錯誤再次發生, 請清潔邊界感應器 (圖 0-1)。</p>
 指示燈每次閃爍 3 下	<ul style="list-style-type: none"> • 發生緩衝器感應器錯誤。 <p>→ 推動緩衝器 (圖 P-2) 10 次。</p>
 指示燈每次閃爍 4 下	<ul style="list-style-type: none"> • 線和毛髮糾結在驅動輪上。 <p>→ 將它們從驅動輪 (圖 M-2) 上清除。 <ul style="list-style-type: none"> • 自動掃地機器人通過狹窄區域, 造成頂部表面被壓下去。 <p>→ 這不是故障。</p> </p>
 指示燈每次閃爍 5 或 7 下	<ul style="list-style-type: none"> • 自動掃地機器人過熱。 <p>→ 關閉自動掃地機器人, 取下電池匣, 並等待一小時。使用自動掃地機器人的環境室溫不得超過 40°C。</p>
 和  指示燈每次閃爍 1 下。	<ul style="list-style-type: none"> • 未安裝集塵盒或濾網。 <p>→ 請安裝集塵盒或濾網。</p>
 和所有的  指示燈每次閃爍 1 下	<ul style="list-style-type: none"> • 剩餘的電池電力不夠 ( 或 )。無法開始清掃。 <p>→ 請將電池匣完全充滿電。</p>
 和  指示燈亮起	<ul style="list-style-type: none"> • 線和毛髮糾結在驅動輪中。 <p>→ 將它們從驅動輪 (圖 M-2) 上清除。 <ul style="list-style-type: none"> • 自動掃地機器人通過狹窄區域, 造成頂部表面被壓下去。 <p>→ 這不是故障。</p> </p>
 和  指示燈亮起	<ul style="list-style-type: none"> • 發生感應器錯誤。 <p>→ 關閉自動掃地機器人, 然後再次開啟。</p>
 和  指示燈亮起	<ul style="list-style-type: none"> • 自動掃地機器人發生錯誤。 <p>→ 關閉自動掃地機器人, 然後再次開啟。</p>
 指示燈每次閃爍 1 下	<ul style="list-style-type: none"> • 線和毛髮糾結在邊刷和主刷中。 <p>→ 將它們從刷子上清除 (圖 A、N-3)。</p>
 指示燈亮起	<ul style="list-style-type: none"> • 集塵盒已裝滿塵土或濾網堵塞。 <p>→ 清空集塵盒 (圖 K-2) 並清潔濾網 (圖 K-5)。</p>

疑難排解

附註: 如果採取修復動作後, 問題依然存在, 請洽詢您最近的 Makita 服務中心。

徵兆	原因/解決方法
當您按下  按鈕時, 指示燈未亮起。	<ul style="list-style-type: none"> → 正確安裝電池匣。 → 請將電池匣完全充滿電。 → 按下  按鈕, 啟動自動掃地機器人。
當您按下自動掃地機器人或遙控器上的按鈕時, 自動掃地機器人並未操作。	<ul style="list-style-type: none"> → 如果  故障排除指示燈、 濾網維護指示燈或  刷子維護指示燈亮起或閃爍, 請參閱「修復自動掃地機器人」以解決問題。 → 如果導向指示燈慢慢閃爍, 請按住自動掃地機器人上的  電源按鈕, 直到所有指示燈熄滅, 或按下遙控器上的  電源關閉按鈕以清除計時器。
自動掃地機器人沒有操作。	<ul style="list-style-type: none"> → 如果  故障排除指示燈、 濾網維護指示燈或  刷子維護指示燈亮起或閃爍, 請參閱「修復自動掃地機器人」以解決問題。 → 如果導向指示燈慢慢閃爍, 請按住自動掃地機器人上的  電源按鈕, 直到所有指示燈熄滅, 或按下遙控器上的  電源關閉按鈕以清除計時器。
自動掃地機器人自動開始操作。	<ul style="list-style-type: none"> • 自動啟動計時器已啟動。
自動掃地機器人在清潔中停止操作。	<ul style="list-style-type: none"> → 關閉自動掃地機器人, 然後清除驅動輪上的所有電線、繩子等異物。 → 如果自動掃地機器人卡在阻隔物或其他障礙物上, 請將自動掃地機器人移到其他位置。
巡航速度不定。	<ul style="list-style-type: none"> • 如果偵測到障礙物, 自動掃地機器人會慢下來, 因為需要時間計算行進方向。這並非自動掃地機器人故障。
自動掃地機器人沒有直線前進。	<ul style="list-style-type: none"> → 關閉自動掃地機器人, 然後清除驅動輪上糾結的所有異物。 → 清潔超音波感應器。
自動掃地機器人比過去更常碰撞障礙物。	<ul style="list-style-type: none"> → 清潔超音波感應器。 • 自動掃地機器人可能無法避開 5.5 公分或更低的高度落差。這並非自動掃地機器人故障。
自動掃地機器人掉落樓梯或較低的地面。	<ul style="list-style-type: none"> → 清潔邊界感應器。 • 自動掃地機器人可能無法避開 5.5 公分或更低的高度落差。這並非自動掃地機器人故障。
運作聲音比平常更大聲。	<ul style="list-style-type: none"> → 清空集塵盒並清潔濾網、邊刷和主刷。
吸力不夠, 無法吸取塵土。	<ul style="list-style-type: none"> → 清空集塵盒並清潔濾網。 → 按下自動掃地機器人或遙控器上的  吸塵器按鈕, 以啟動吸塵器風扇。
邊刷掉落。	<ul style="list-style-type: none"> → 正確安裝邊刷 (圖 A)。
邊刷未旋轉, 或旋轉困難。	<ul style="list-style-type: none"> → 清潔邊刷和主刷。 → 正確安裝主刷和底板 (圖 N)。
排出的氣體有異味。	<ul style="list-style-type: none"> → 清空集塵盒並清潔濾網。
遙控器無法運作。	<ul style="list-style-type: none"> → 正確安裝遙控器電池 (圖 E)。 → 更換新電池。 → 按下自動掃地機器人上的  電源按鈕, 將它啟動。 → 靠近自動掃地機器人一點, 或移除自動掃地機器與遙控器之間的障礙物。 → 不要在使用無線電頻率 2.4 GHz 波段的設備 (廚房微波爐、藍芽裝置、Wi-Fi 裝置等) 附近使用自動掃地機器人, 或將自動掃地機器人移走。 → 關閉自動掃地機器人, 然後再次開啟。
自動啟動計時器無法操作。	<ul style="list-style-type: none"> → 請使用完全充滿電的電池匣。 → 重新啟動自動啟動計時器。

選購配件

⚠注意：針對本手冊中指定的 Makita 工具，建議搭配這些配件或附件使用。使用其他任何配件或附件可能會導致人身傷害風險。請依照配件或附件的指定目的使用。

- 阻隔帶
- 邊刷
- 主刷
- 底板
- 濾網
- Makita 原廠電池與充電器

附註：本清單中的部分項目可能作為標準配件包含在工具包中。它們可能因國家而有所不同。

參考資訊

Makita Corporation 及其子公司、分公司及經銷商可能會使用「使用資訊」作為售後服務（例如維護與維修）用途。「使用資訊」包含許多運作、配電負載、錯誤資訊、運作狀態和/或電力工具的維護記錄。

根據NCC低功率電波輻射性電機管理辦法 規定：

第十二條

經型式認證合格之低功率射頻電機，非經許可，公司、商號或使用者均不得擅自變更頻率、加大功率或變更原設計之特性及功能。

第十四條

低功率射頻電機之使用不得影響飛航安全及干擾合法通信；經發現有干擾現象時，應立即

停用，並改善至無干擾時方得繼續使用。

前項合法通信，指依電信法規定作業之無線電通信。

低功率射頻電機須忍受合法通信或工業、科學及醫療用電波輻射性電機設備之干擾。

한국어(사용 설명서)

경고: 어린이를 포함해서 체력이 약하거나 정신적으로 문제가 있거나 지식과 경험이 없는 사람은 본 공구를 사용하지 마십시오. 어린이가 본 기기를 가지고 놀지 못하도록 주의하여 주십시오.

사양

표준 배터리 카트리지	BL1815N, BL1820B, BL1830B, BL1840B, BL1850B, BL1860B
배터리 수명 (별매 리튬 이온 배터리 사용 시)	BL1830 두 개(각 18V, 3Ah) 사용 시 약 120분
	BL1850 두 개(각 18V, 5Ah) 사용 시 약 200분
먼지통 용량	2.5L
크기(w/h) (BL1830 배터리 포함)	약 460 x 460 x 180mm
무게(BL1830 배터리 2개 포함)	약 7.8kg

- 지속적인 연구 개발 프로그램으로 인해 본 사양은 예고 없이 변경될 수 있습니다.
- 사양은 국가별로 상이할 수 있습니다.

기호



사용 설명서를 참조하십시오.



로봇 청소기를 밟거나 물건을 올리지 마십시오.



불꽃, 가연성 및/또는 위험 물질 근처에서 로봇 청소기를 사용하지 마십시오.



바닥면의 낙차 센서가 더럽거나 젖은 경우 청소하십시오.

용도

본 로봇 청소기는 실내 바닥 청소용입니다. 리모컨은 로봇 청소기에 무선(2.4GHz ZigBee)으로 연결됩니다.

안전 지침



로봇 청소기로 가연성 물질을 빨아들이거나 가연성 물질 근처에서 사용하지 마십시오. 폭발이나 화재가 발생할 수 있습니다.

- 등유, 휘발유, 향, 촛불
- 벤진, 신너
- 담배꽂초
- 토너 또는 기타 연소성 물질
- 카펫 클리너 또는 기타 거품 물질

젖은 장소, 젖을 수 있는 장소 또는 온도와 습도가 높은 장소에서 로봇 청소기를 사용하지 마십시오. 또한 물을 빨아들이지 마십시오.

이 경우 감전, 단락, 화재, 변형 또는 고장이 발생할 수 있습니다.

- 물을 사용하는 부엌 및 기타 장소
- 욕실
- 샤워실
- 다락 등

로봇 청소기를 젖은 손으로 만지지 마십시오. 감전될 수 있습니다.

스토브 또는 기타 전열 기구 근처에서 로봇 청소기를 사용하지 마십시오.

이 경우 감전, 단락, 화재, 변형 또는 고장이 발생할 수 있습니다.

다음과 같은 장소에서는 로봇 청소기를 사용하지 마십시오.

감전 또는 부상이 발생할 수 있습니다.

- 신체, 지각 또는 정신적 능력이 떨어지거나 경험 및 지식이 부족한 사람 또는 유아 근처
- 동물 근처
- 사람이 많은 곳이나 왕래가 잦은 곳

보호자 없는 어린이 또는 의사를 표현할 수 없거나 로봇 청소기를 스스로 조작할 수 없는 사람이 로봇 청소기를 사용하지 못하도록 하십시오. 감전 또는 부상이 발생할 수 있습니다.

다음과 같은 이상 현상 또는 오작동이 발생하는 경우 즉시 작동을 중지하십시오.

이 지침을 따르지 않을 경우 연기, 화재 또는 감전이 발생할 수 있습니다.

- 로봇 청소기의 전원을 켜도 작동하지 않는 경우
- 로봇 청소기가 변형되었거나 비정상적으로 뜨거운 경우
- 로봇 청소기가 작동 중 가끔 멈추는 경우
- 로봇 청소기 작동 중 비정상적 소음이 발생하는 경우
- 로봇 청소기에서 타는 냄새가 나는 경우

사용이 금지된 장소에서는 로봇 청소기를 끄십시오.
이 지침을 따르지 않을 경우 의료 장비의 오작동을
초래할 수 있습니다.

의료 시설 내에서 무선파를 방출하는 장비를 사용할
때는 각 의료 기관의 지침을 준수하십시오.

좁고 테두리가 없는 곳에서는 로봇 청소기를 사용하지
마십시오.

로봇 청소기가 낙하하여 부상 또는 고장이 발생할 수
있습니다.

- 계단
- 탁자, 선반, 화장대, 냉장고 등의 위
- 종이층, 로프트, 계단통이나 입구로 바로 떨어지는
바닥 등
- 경사가 10도 이상인 곳

로봇 청소기를 직사 광선이나 적외선에 노출시키지
마십시오.

센서 오류로 부적절한 작동이 수행되어 로봇 청소기
낙하로 인한 부상이나 고장이 발생할 수 있습니다.

- 할로겐 히터
- 리모컨 또는 센서 등
- 서리로 덮인 유리창을 통해 들어오는 태양광

로봇 청소기와 접촉 시 사고가 발생할 수 있는 다른
물건을 치우십시오.

이 지침을 따르지 않을 경우 물건이 넘어지거나
낙하하여 부상이 발생할 수 있습니다.

- 불이 켜진 촛불, 꽃병 등
- 로봇 청소기와 같은 높이에 조작 버튼이 있는
전자 제품

로봇 청소기를 덮지 마십시오.

과열로 인해 화재가 발생할 수 있습니다.

로봇 청소기 위에 올라타거나 무거운 물체를 올리지
마십시오. 강한 물리적 충격을 가하지 마십시오.
부상, 손상 또는 오작동이 발생할 수 있습니다.

로봇 청소기 근처의 어린이에 특히 주의를
기울이십시오.

로봇 청소기를 절대 개조하지 마십시오.

화재, 감전 또는 부상이 발생할 수 있습니다.
수리가 필요한 경우 로봇 청소기를 구매한 대리점에
문의하십시오.

흡기 또는 배기 구멍을 막거나 금속성 또는 연소성
물질물 놓지 마십시오. 또한 흡기구를 막을 수 있는
물체 근처에서 로봇 청소기를 사용하지 마십시오.
감전, 화재 또는 오작동이 발생할 수 있습니다.

로봇 청소기를 가열하거나 불꽃에 노출시키지 말아야
하며 불꽃이나 난로 근처, 직사 광선에 노출되는 곳,
더운 날씨의 차량 내부 등과 같은 뜨거운 장소에 두지
마십시오.

이 경우 단락 또는 화재가 발생하거나 배터리가
누출되거나 폭발할 수 있습니다.

로봇 청소기를 물이나 세제로 세척하거나 물이나
세제에 노출시키지 마십시오.*
감전, 단락 또는 화재가 발생할 수 있습니다.

* 메인 브러시, 바닥판, 측면 브러시, 먼지통 및
필터 제외

작동 중 로봇 청소기 아래에 손이나 발을 넣거나 구동
휠을 만지지 마십시오.

부상을 입을 수 있습니다.

로봇 청소기 근처의 어린이에 특별히 주의를
기울이십시오.

로봇 청소기의 센서를 막거나 이물질물 놓지 마십시오.
오작동이나 기능 이상으로 인해 로봇 청소기가
낙하하여 다치거나 고장이 발생할 수 있습니다.

센서나 휠에 테이프를 부착하지 마십시오. 범퍼 또는
휠 모양을 개조하거나 범퍼를 강한 힘으로 누르지
마십시오.

오작동이나 기능 이상으로 인해 로봇 청소기가
낙하하여 부상 또는 고장이 발생할 수 있습니다.

각 센서를 주기적으로 청소하십시오.

이 지침을 따르지 않을 경우 오작동이나 기능 이상으로
인해 로봇 청소기가 낙하하여 다치거나 고장이 발생할
수 있습니다.

오염되거나 벗겨지거나 찢어진 경계 테이프(별매)를
사용하지 마십시오.

작동 장애로 로봇 청소기가 낙하하여 부상을 입을 수
있습니다.



주의

다음 장소에서는 로봇 청소기를 사용하지 마십시오.
다른 장비가 정상적으로 작동하지 않을 수 있습니다.

- 병원 내부 또는 의료 장비 근처
- 항공기 내부
- 정밀한 제어 또는 약한 신호를 사용하는 전자
장비 근처

로봇 청소기와 리모컨은 이식형 인공심장 박동기 및
자동제동기에서 15cm 이상 떨어뜨리십시오.
이 지침을 따르지 않을 경우 의료 장치의 오작동이
발생할 수 있습니다.

틈이나 구멍에 이물질물 놓지 마십시오.

감전 또는 부상이 발생할 수 있습니다.

로봇 청소기를 청소할 때 손가락이 끼지 않도록
주의하여 주십시오.
부상을 입을 수 있습니다.

로봇 청소기를 사용하기 전에 본 사용 설명서를 잘
읽으시기 바랍니다.

이 지침을 따르지 않을 경우 부상 또는 오작동이 발생할
수 있습니다.



유의사항

배터리 카트리지에서 좋지 않은 냄새, 배터리 누출,
비정상적인 열, 변형 또는 변색이 발견된 경우 즉시
사용을 중단하십시오.

이 지침을 따르지 않을 경우 오작동이 발생할 수
있습니다.

로봇 청소기를 실외 또는 실외로 나갈 수 있는 장소에서
사용하지 마십시오.
오작동이 발생할 수 있습니다.

다음 장소에서는 로봇 청소기를 사용하지 마십시오.
오작동이 발생할 수 있습니다.

- 식용유 입자나 기타 오일 성분이 공기 중에 부유하고 있는 장소
- 이발소, 미장원 및 드라이 클리닝 세탁소처럼 분무제나 화학 제품이 사용되는 장소
- 먼지가 많은 장소

다음 장소에서는 로봇 청소기를 사용하지 마십시오.
이 경우 바닥 덮개가 손상되거나 바닥이 긁힐 수 있습니다.

- 손상되기 쉬운 바닥 덮개(양피, 펠트 재질 등)가 깔려 있는 장소
- 마감되지 않은 목재 또는 대리석 바닥
- 새로 왁스칠한 바닥

긴 털(7mm 이상)의 바닥 덮개가 깔린 곳에는 로봇 청소기를 사용하지 마십시오.

바닥 덮개가 손상되거나 로봇 청소기가 고장날 수 있습니다.

콘크리트 바닥처럼 단단하고 평평하지 않은 바닥면에 로봇 청소기를 사용하지 마십시오.

브러시 및 휠 마모가 심해질 수 있습니다.

브러시 또는 휠이 마모된 경우에는 로봇 청소기를 사용하지 마십시오.

바닥 표면이 긁힐 수 있습니다.

이 경우 로봇 청소기의 작동을 중단하고 구입한 대리점에 문의하십시오.

메인 브러시, 측면 브러시 및 휠에 부착된 꺼질꺼칠한 면지를 모두 제거하십시오.

이 지침을 따르지 않을 경우 바닥 표면이 손상될 수 있습니다.

다음과 같은 물질을 빨아들이지 마십시오.

이 경우 로봇 청소기 내부가 막히거나 긁힐 수 있으며 고장이 발생할 수도 있습니다.

- 액체 또는 젖은 쓰레기
- 화학 물질 또는 기름
- 애완동물 배설물
- 많은 양의 모래나 분말
- 날카로운 물체(유리, 칼날, 핀 등)
- 많은 종이 또는 비닐 쓰레기
- 실이나 끈

미세한 분말(분말 석고, 시멘트, 분필 등)을 빨아들이 후에는 필터를 청소하십시오.

이 지침을 따르지 않을 경우 오작동이 발생할 수 있습니다.

필터가 막혔거나 센서가 오염된 경우 로봇 청소기를 사용하지 마십시오.

오작동이 발생할 수 있습니다.

회전 브러시 또는 기타 움직이는 부품에 오일을 바르지 마십시오.

플라스틱이 파손될 수 있습니다.

위의 지시 사항을 준수하여 주십시오.

배터리 공구의 사용 및 관리

1. 제조사에서 지정한 충전기만 사용하여 충전하십시오. 특정 형태의 배터리 팩에 사용하는 충전기를 다른 배터리 팩에 사용할 경우 화재의 위험이 있을 수 있습니다.
2. 전동 공구에는 지정된 전용 배터리 팩만 사용하십시오. 다른 배터리 팩을 사용하면 부상이나 화재의 위험이 있습니다.
3. 배터리 팩을 사용하지 않을 때는 종이 클립, 동전, 열쇠, 못, 나사 및 단자 간 접촉을 초래할 수 있는 기타 작은 금속 물체가 없는 곳에 보관하십시오.
4. 가혹 조건에서 사용할 경우 배터리에서 액이 누출될 수 있으므로 몸에 닿지 않도록 주의하십시오. 실수로 접촉한 경우에는 물로 씻어 주십시오.

배터리 카트리지에 대한 중요한 안전 지침

1. 배터리 카트리지를 사용하기 전에 (1) 배터리 충전기 (2) 배터리 (3) 배터리를 사용하는 제품의 모든 지침 및 주의 표시를 숙지하여 주십시오.
2. 배터리 카트리지를 분해하지 마십시오.
3. 작동 시간이 평소보다 많이 짧아진 경우에는 작동을 즉시 멈추십시오. 과열이나 화학 혹은 폭발의 위험이 있습니다.
4. 전해질이 눈에 들어간 경우에는 깨끗한 물로 씻어낸 다음 즉시 치료를 받으십시오. 시력을 잃을 수 있습니다.
5. 배터리 카트리지를 단락시키지 마십시오.
 - (1) 전도성 물질로 단자를 접촉하지 마십시오.
 - (2) 못, 동전 등과 같은 금속 물질이 들어 있는 용기에 배터리 카트리지를 보관하지 마십시오.
 - (3) 배터리 카트리지를 물이나 비에 노출시키지 마십시오.

배터리가 단락되어 과전류, 과열, 화학 및 고장이 일어날 수 있습니다.
6. 온도가 50°C 이상으로 올라갈 수 있는 곳에 로봇 청소기와 배터리 카트리지를 보관하지 마십시오.
7. 심하게 손상되었거나 완전히 소진된 경우라도 배터리 카트리지를 소각하지 마십시오. 배터리 카트리지가 폭발할 수 있습니다.
8. 배터리 카트리지를 떨어뜨리거나 충격을 가하지 마십시오.
9. 손상된 배터리 카트리지를 사용하지 마십시오.
10. 배터리 카트리지의 폐기에 관해서는 지역 규정에 따르십시오.

위의 지시 사항을 준수하여 주십시오.

⚠주의: 정품 Makita 배터리만 사용하십시오. 비순정품 Makita 배터리 또는 개조된 배터리를 사용하면 배터리 폭발이 발생하여 화재, 개인 부상 및 손상의 원인이 될 수 있습니다. 또한, Makita 공구 및 충전기에 대한 Makita 보증이 무효가 됩니다.

배터리 수명을 최대로 유지하는 방법

1. 배터리 카트리지가 완전히 방전되기 전에 충전하십시오. 공구의 힘이 약해진 것을 감지하면 항상 작동을 멈추고 배터리 카트리지를 충전하십시오.
2. 완전히 충전된 배터리 카트리지를 재충전하지 마십시오. 과충전은 배터리의 수명을 단축시킵니다.
3. 실내 온도 10℃~40℃에서 배터리 카트리지를 충전하십시오. 배터리 카트리는 충분히 식은 후 충전하십시오.
4. 배터리 카트리지를 장시간 (6개월 이상) 보관할 때는 충전 후 보관할 것을 권장합니다.

공구/배터리 카트리지 보호 시스템

로봇 청소기에는 로봇 청소기와 배터리 카트리지의 수명을 늘리기 위해 모터 전원을 자동으로 차단하는 공구/배터리 카트리지 보호 시스템이 장착되어 있습니다. 다음 조건에서는 로봇 청소기가 자동으로 중지됩니다.

과부하

로봇 청소기가 과부하되어 비정상적으로 높은 전류가 유입되면 별도 표시 없이 로봇 청소기가 자동으로 멈춥니다.

로봇 청소기를 다시 시작하려면 전원을 끄고 과부하의 원인을 제거한 다음 다시 전원을 켜십시오.

과열

로봇 청소기가 과열되면 ▲가 5번 또는 7번 깜박이고 로봇 청소기가 자동으로 멈춥니다.

이 경우 로봇 청소기가 식을 때까지 기다린 후 다시 전원을 켜십시오.

과방전

배터리 잔량이 낮으면 로봇 청소기가 자동으로 멈추고 어떠한 스위치 조작에도 반응하지 않습니다.

이 경우 배터리 카트리지를 분리하여 충전하십시오.

버튼 및 표시등

각 부품에 대한 자세한 내용은 본 설명서에서 해당 부품에 해당하는 그림 번호를 찾아서 확인할 수 있습니다(예: 전원 버튼의 경우 “그림 F-8” 검색).

로봇 청소기(그림 F)

1. 파워렛 램프
2. ▲ 문제 해결 램프
3. ㄱ 필터 관리 램프
4. ☼ 브러시 관리 램프
5. [배터리 표시등(우측 및 좌측 배터리 카트리지용)]
6. ⌚ 타이머 버튼 및 램프
7. ↶ 크루즈 모드 버튼 및 램프
 ▶ : 패턴 모드
 ✕ : 랜덤 모드
8. ⏻ 전원 (시작/중지) 버튼
9. 🔊 부저 버튼 및 램프
10. 🌀 진공 버튼 및 램프
11. 📶 경계 센서 버튼 및 램프

리모컨(그림 G)

1. ⏻ 전원 끄기 버튼
2. ▶▶ 시작/중지 버튼
3. 📶 위치 알람 버튼
4. ▶/✕ 크루즈 모드 버튼
5. ⌚ 타이머 버튼
6. 🔊 부저 버튼
7. 🌀 진공 버튼

사용하기 전에

조립 및 배터리 설치

▲주의: 로봇 청소기에 어떤 작업을 수행할 때는 먼저 로봇 청소기 전원을 끄십시오.

동봉 부속품

다음 목록의 품목이 패키지에 포함되어 있는지 확인하십시오.

- AAA(LR03) 배터리(2개)
- 측면 브러시(4개, 여분 브러시 2개 포함)
- 측면 브러시 설치용 나사(4개)
- 경계 테이프(15m, 1개)
- 사용 설명서(1개)
- 빠른 시작 안내서(1개)
- 사용 주의 사항(1개)

측면 브러시 설치(그림 A)

로봇 청소기 전방 아래의 양 측면에 측면 브러시를 설치합니다.

유의사항: 작업 전에 바닥과 로봇 청소기의 손상을 방지하기 위해 러그나 기타 완충재를 바닥에 까십시오(그림 B).

1. 측면 브러시를 브러시 홈이 샤프트 헤드에 맞도록 로봇 청소기의 회전 샤프트 헤드에 위치시킵니다.
2. 제공된 나사를 사용하여 측면 브러시를 고정합니다.

유의사항: 측면 브러시를 설치한 상태에서 로봇 청소기를 작동하십시오.

배터리 카트리지 설치

배터리 카트리지의 홈(그림 C-2)을 배터리 도크의 돌출부(그림 C-3)에 맞춰서 밀니다. 딸깍 소리가 나면서 제자리에 고정될 때까지 밀어 넣습니다.

해제 버튼 위쪽에 빨간색 표시등(그림 C-1)이 보이면 배터리 카트리가 완전히 잠기지 않은 것입니다.

▲주의: 배터리 카트리지 설치 시 도크와 배터리 카트리지 사이에 손가락이 끼지 않도록 주의해야 합니다.

로봇 청소기는 두 배터리 도크 중 하나에, 하나의 배터리 카트리가 설치된 경우에만 작동합니다.

배터리 카트리지를 분리하려면 카트리지의 해제 버튼(그림 D-1)을 누른 채 배터리 도크에서 밀어 꺼냅니다.

리모컨에 배터리 설치(그림 E)

배터리 격실 뚜껑을 밀어서 열고 두 개의 AAA(LR03) 크기 배터리를 극성(+/-)에 맞게 삽입합니다.





유의사항: 오래된 배터리와 새 배터리를 함께 사용하거나 다른 종류의 배터리를 함께 사용하지 않아야 합니다.

유의사항: 리모컨을 장시간 사용하지 않을 때는 배터리를 분리해 두십시오.

⚠주의: 배터리에서 누출된 전해액이 피부나 눈에 닿은 경우에는 즉시 물로 씻으십시오.

로봇 청소기와 리모컨 페어링

로봇 청소기는 리모컨과 페어링되어 출하됩니다. 하지만 리모컨을 교체한 경우에는 페어링을 다시 수행해야 합니다.

1. 부저음이 두 번 울릴 때까지 로봇 청소기의  타이머(그림 F-6) 및  크루즈 모드(그림 F-7) 버튼을 동시에 길게 누릅니다.
2. 부저음이 한 번 울릴 때까지 리모컨의  타이머(그림 G-5) 및  위치 알림 버튼(그림 G-3)을 동시에 길게 누릅니다.

페어링이 실패하고 부저음이 5번 울리면 페어링을 다시 시도하십시오.

방 정리

원활한 이동을 위해

- 방문을 닫습니다. 방의 문턱 높이가 낮아서 로봇 청소기가 문제 없이 넘어갈 수 있는 경우에는, 로봇 청소기가 방으로 이동하여 계속 청소할 수 있도록 문을 열어두어도 됩니다.
- 손상되기 쉬운 가구 등이 있는 경우 그 앞에 장애물을 두십시오.
- 낮은 선반의 하단부처럼 로봇 청소기가 걸릴 수 있는 위치에는 들어가지 못하도록 장애물을 두십시오.
- 가늘고 높으며 불안정한 물건과 기타 넘어지기 쉬운 물건은 다른 방법으로 옮깁니다.
- 카드 등의 물건은 바퀴를 잠그거나 다른 방법으로 옮깁니다.
- 전기 코드는 벽을 따라 정돈합니다.
- 로봇 청소기가 다른 방으로 이동하는 데 방해가 될 수 있는 쿠션, 책 등의 물건을 다른 방으로 옮깁니다.
- 바닥에 늘어뜨려진 커튼 등의 물건을 올려둡니다.
- 높이 차이가 있거나 가닥이 빨려 들어갈 수 있는 바닥 덮개와 얇아서 미끄러지기 쉬운 바닥 덮개는 모두 다른 방으로 옮깁니다.
- 바닥 덮개의 장식용 솔은 모두 바닥 덮개 아래로 접어 넣습니다.
- 빨려 들어가기 쉬운 작은 물체 또는 귀중품을 치웁니다.
- 바닥에 놓인 줄, 벨트, 끈, 얇은 종이 또는 비닐 봉투 등을 모두 치웁니다.
- 집어넣을 수 있는 전원 소켓은 집어넣습니다.
- 바닥 구획을 나누는 격자 등은 로봇 청소기가 이를 경계로 감지하여 건너가지 않을 수 있으므로 보드 등으로 덮습니다.

로봇 청소기 낙하 방지

- 청소할 구역에 로봇 청소기가 낙하할 수 있는 계단 등이 있는 경우에는 로봇 청소기가 해당 구역에 가지 않도록 하기 위해, 그 앞에 높이가 15cm 이상이며 로봇 청소기가 부딪쳐도 넘어지지 않을 정도로 무거운 물체를 두십시오.
- 태양광 및 적외선을 커튼으로 차단하십시오. (로봇 청소기가 직사 광선이나 적외선을 피하기 위해 물러날 때 낮은 면으로 낙하할 수 있습니다.)
- 알루미늄 새시 문을 닫습니다. (로봇 청소기가 알루미늄 새시 레일과 바닥 간의 높이 차이를 감지하지 못하여 문 밖으로 떨어질 수 있습니다.)
- 높이 차가 있는 곳 근처의 바닥 덮개를 다른 방으로 옮깁니다. (로봇 청소기가 차이를 감지하지 못하여 낙하할 수 있습니다.)

주석

- 로봇 청소기로 가연성 물질을 빨아들이거나 가연성 물질 근처에서 사용하지 마십시오. (폭발이나 화재가 발생할 수 있습니다.)
- 젖은 장소, 젖을 수 있는 장소 또는 온도와 습도가 높은 장소에서 로봇 청소기를 사용하지 마십시오. 또한 물을 빨아들이지 마십시오. (이 경우 감전, 단락, 화재, 변형 또는 고장이 발생할 수 있습니다.)
- 높이 차이가 있는 곳에서 벽까지의 거리가 1m 이하인 곳에서는 로봇 청소기를 사용하지 마십시오. (드문 경우 로봇 청소기가 물러나면서 떨어질 수 있습니다.)
- 벽이나 장애물 근처에 로봇 청소기가 올라갈 수 없는 물체가 있는 장소에서는 로봇 청소기를 사용하지 마십시오. 로봇 청소기가 벽이나 장애물을 피하기 위해 뒤로 움직일 때 물체에 걸릴 수 있습니다.
- 홈 보안 시스템 등은 모두 해제하십시오(로봇 청소기가 침입자로 잘못 감지될 수 있습니다).
- 로봇 청소기는 5.5cm 이하의 높이 차이는 피하지 못할 수 있습니다.
- 작동 중 TV 화면에 노이즈가 나타날 수 있습니다. (이는 텔레비전의 오작동이 아닙니다.)
- 로봇 청소기에 배터리 카트리지를 설치한 채 장시간 두지 마십시오. (배터리 전해액이 누출될 수 있습니다.)
- 배터리 카트리지가 설치된 로봇 청소기를 위아래로 뒤집지 마십시오. (버튼이 눌러져서 의도치 않은 작동이 수행될 수 있습니다.)

작동

로봇 청소기는 초음파 센서(그림 P-1)를 사용해 장애물을 피하며 사전 설정된 크루징 모드에 따라 바닥을 이동하면서, 측면 브러시, 메인 브러시 및 진공 팬으로 경로상의 먼지 및 기타 이물질을 빨아 들입니다. 하지만 특정 상황에서는 센서가 장애물을 감지하지 못할 수 있습니다. 로봇 청소기가 장애물에 부딪치면 로봇 청소기의 범퍼(그림 P-2)가 충격을 흡수하고 이동 방향을 바꿉니다.

주석: 로봇 청소기는 최대 높이 1.5cm의 턱을 넘어가도록 설계되었지만 경우에 따라 이러한 턱을 넘지 못할 수 있습니다.

주석: 로봇 청소기는 검은색이나 검은색 우드그레인 패턴이 있는 곳 또는 유리 재질로 만들어진 곳을 피할 수 있습니다.

주석: 특정 조건에서는 청소 주기가 끝나도 먼지가 남아 있을 수 있습니다.

주석: 다음 조건에서는 무선 통신이 방해되거나 차단될 수 있습니다.







- 강화 콘크리트 또는 금속성 건축 자재로 만들어진 구조물 내부
- 로봇 청소기가 장애물 뒤에 있을 때
- 동일한 주파수 대역을 사용하는 무선 통신 장비 근처
- 전자기장(전자렌지 등) 또는 정전기를 발생하거나 무선 전파 간섭을 초래하는 장치의 근처

기본 작동

▲주의: 로봇 청소기의 기능을 조정 또는 점검할 때는 항상 로봇 청소기의 전원을 끄십시오.



유의사항: 이슬이 맺힌 경우에는 로봇 청소기 전원을 끄고 로봇 청소기가 마를 때까지 기다린 후 작동을 다시 시작하십시오.

유의사항: 로봇 청소기를 끄더라도 모든 설정이 지워지는 않습니다. 예기치 않은 동작을 방지하기 위해 각 램프(그림 F-6, 7, 9, 11)를 통해 설정이 올바른지 확인하십시오.

1. 로봇 청소기의  전원 버튼(그림 F-8)을 누릅니다.
로봇 청소기가 대기 모드에 들어가고  배터리 표시등(그림 F-5)이 켜집니다. (자세한 내용은 아래의 “로봇 청소기의 배터리 표시등”을 참조하십시오.)
2. 로봇 청소기의  크루즈 모드 버튼(그림 F-7)을 여러 번 눌러 모드를 선택하거나 리모컨의  또는  크루즈 모드 버튼(그림 G-4)을 누릅니다.
선택된 모드 램프가 켜집니다. (자세한 내용은 아래의 “크루즈 모드”를 참조하십시오.)
3. 로봇 청소기의  전원 버튼(그림 F-8) 또는 리모컨의  시작/중지 버튼(그림 G-2)을 눌러 청소를 시작합니다.
청소 도중 파일럿 램프(그림 F-1)가 깜박이고 부저음이 울립니다.

청소를 일시 중지하려면 3단계를 다시 수행합니다.

청소를 다시 시작하려면 3단계를 다시 수행합니다.





로봇 청소기를 끄려면 로봇 청소기의  전원 버튼(그림 F-8)을 표시등이 꺼질 때까지 길게 누르거나, 리모컨의  전원 끄기 버튼(그림 G-1)을 누릅니다.

▲주의: 파일럿 램프 불빛을 직접 바라보거나 빛이 눈에 들어오지 않도록 주의하십시오. 눈에 해로울 수 있습니다.

로봇 청소기의 배터리 표시등

해당 배터리 카트리지 측에 있는 배터리 표시등이 배터리 카트리지의 잔량을 표시합니다.

유의사항: 아래 표는 배터리 잔량에 대한 대략적인 표시입니다. 잔량은 사용 조건 및 실내 온도에 따라 달라질 수 있습니다.







	50% 이상
	20% ~ 50% 사이
	20% 이하
	비어 있음/배터리 카트리지 설치되지 않음
	배터리 오류

배터리 카트리지의 배터리 표시등

모델 번호가 “B”로 끝나는 배터리 카트리지의 경우 배터리 카트리지의 배터리 표시등(그림 I-1)을 사용하여 잔량을 확인할 수도 있습니다.

배터리 카트리지를 분리하고  버튼(그림 I-2)을 누릅니다.

유의사항: 아래 표는 배터리 잔량에 대한 대략적인 표시입니다. 잔량은 사용 조건 및 실내 온도에 따라 달라질 수 있습니다.

	75% 이상
	50% ~ 75% 사이(50% 포함)
	25% ~ 50% 사이
	25% 이하
	비어 있음
	배터리 오류

<p>↗ 패턴 모드</p>	<p>적용: 잘 정리된 창고나 긴 걸러리처럼 장애물이 별로 없는 넓은 바닥. 설명(그림 H-1): 로봇 청소기가 세로(a) 및 가로(b) 이동의 주기를 반복합니다.*</p>
<p>✕ 랜덤 모드</p>	<p>적용: 사무실처럼 장애물이 많은 바닥. 설명(그림 H-2): 로봇 청소기가 임의 이동(c)하고 벽을 따라 이동(d)하는 주기를 반복합니다.</p>

* 로봇 청소기의 실제 이동 경로는 조건에 따라 이차트와 달라질 수 있습니다.

주석: 로봇 청소기는 로봇 청소기가 이동할 수 없거나 축면 브러시가 닿지 않는 좁은 곳은 청소할 수 없습니다.
주석: 청소 주기가 끝난 후 일부 조건에서는 바닥에 먼지가 남아 있을 수 있습니다.

슬립 모드

로봇 청소기의 대기 모드가 약 5분 이상 지속되면 로봇 청소기는 배터리 절약을 위해 자동으로 슬립 모드에 들어가며 파일럿 램프(그림 F-1)가 천천히 깜박입니다. 자동 켜짐 타이머가 작동할 때도 슬립 모드에 들어갑니다. 대기 모드로 돌아가려면 "기본 작동"의 3단계를 수행하십시오.

유의사항: 이 모드에서는 청소 동작의 시작 및 설정 변경을 수행할 수 없습니다.

로봇 청소기 운반

- ▲ 주의: 로봇 청소기를 운반할 때는 먼저 로봇 청소기 전원을 끄십시오.
- ▲ 주의: 핸들과 로봇 청소기 본체 사이에 손이 끼지 않도록 주의하십시오.

핸들(그림 J-1)을 잡습니다.

유의사항: 다른 손으로 로봇 청소기 뒤쪽 바닥을 받칠 때는, 로봇 청소기 내의 먼지가 메인 브러시 구멍을 통해 쏟아질 수 있으므로 뒤쪽을 너무 많이 울리지 않도록 주의하십시오.
유의사항: 로봇 청소기를 역지로 잡아당기지 마십시오.

먼지통 비우기

로봇 청소기의 최고 성능을 유지하려면 사용할 때마다 먼지통을 비우십시오.

1. 로봇 청소기의 전원 버튼(그림 F-8)을 표시등이 꺼질 때까지 길게 누르거나, 리모컨의 전원 끄기 버튼(그림 G-1)을 눌러서 로봇 청소기를 끕니다.
2. 상단 뚜껑(그림 K-1)을 눌렀다 떼어서 잠금을 해제한 다음 완전히 개방합니다.
3. 먼지통 상자(그림 K-2)를 꺼냅니다.
4. 두 잠금 장치(그림 K-3)를 풀고 먼지통 상자 뚜껑을 엽니다.
5. 상단 먼지통(그림 K-4)을 꺼내서 비웁니다.
6. 필터(그림 K-5)에 묻은 작은 먼지 덩어리를 제거하고 하단 먼지통(그림 K-6)을 비웁니다.
7. 먼지통 상자를 로봇 청소기에 역순으로 장착합니다.

고급 작동

다음 기능은 로봇 청소기가 대기 모드에 있을 때만 설정할 수 있습니다("기본 작동"의 1단계 참조).

절전

로봇 청소기는 진공 팬을 사용하지 않고도 눈에 보이는 먼지 대부분을 청소할 수 있습니다. 미세한 먼지를 제거할 필요가 없을 때는 진공 팬을 꺼서 배터리 전력을 절약하고 로봇 청소기의 작동 시간을 늘릴 수 있습니다.

대기 모드에서 로봇 청소기(그림 F-10) 또는 리모컨(그림 G-7)의 진공 버튼을 눌러 진공 램프(그림 F-10)를 끕니다.

진공 팬을 켜려면 로봇 청소기(그림 F-10) 또는 리모컨(그림 G-7)의 진공 버튼을 누릅니다. 램프가 다시 켜집니다.

유의사항: 자동 켜짐 타이머가 켜져 있는 슬립 모드에서는 이 설정이 불가능합니다.

유의사항: 진공 팬이 꺼진 경우에는 필터가 먼지로 가득차더라도 필터 관리 램프(그림 F-3)가 켜지지 않습니다.

부저음 볼륨 조정

음 소거를 포함하여 세 가지 부저음 볼륨 중에서 선택할 수 있습니다.

대기 모드에서 로봇 청소기(그림 F-9) 또는 리모컨(그림 G-6)의 부저 버튼을 반복적으로 누릅니다. 버튼을 누를 때마다 부저음이 높은 볼륨(램프 켜짐), 낮은 볼륨(램프 켜짐), 부저 울리지 않음(램프 꺼짐)의 순으로 울립니다.

유의사항: 자동 켜짐 타이머가 켜져 있는 슬립 모드에서는 이 설정이 불가능합니다.

로봇 청소기 찾기

이 기능은 책상, 캐비닛 및 기타 가구들이 놓인 넓은 곳에서 시야를 벗어난 로봇 청소기를 찾을 때 유용합니다.

로봇 청소기가 대기 모드 또는 슬립 모드에 있을 때 리모컨의  위치 알림 버튼(그림 G-3)을 누릅니다. 그러면 부저음이 약 10초 동안 울리고 파일럿 램프가 깜박입니다.

부저음과 깜박임을 중지하려면  위치 알림 버튼을 다시 누릅니다.

주석: 로봇 청소기가 리모컨 범위를 벗어났기 때문에 로봇 청소기가 반응을 하지 않는 경우가 있습니다. 이 문제는 해당 구역을 이동하면서  위치 알림 버튼을 눌러서 해결할 수 있습니다.

자동 켜짐 타이머 사용



지정된 시간이 지나면 로봇 청소기가 자동으로 청소를 시작하는 기능입니다.



자동 시간 지정 청소가 끝나면 설정이 지워지므로 자동 켜짐 타이머를 다시 작동하려면 다음 절차를 수행하십시오.

1. 대기 모드에서 로봇 청소기(그림 F-6) 또는 리모컨(그림 G-5)의  타이머 버튼을 반복적으로 누릅니다. 버튼을 누를 때마다 설정이 다음 순서로 바뀝니다.

램프 상태	청소 시작
	1시간 후
	3시간 후
	5시간 후
	자동 켜짐 타이머가 해제되었습니다.

2. 로봇 청소기의  전원 버튼(그림 F-8)을 누르면 자동 켜짐 타이머가 작동합니다. 로봇 청소기가 슬립 모드에 들어갑니다.

대기 모드에서 타이머를 지우려면 로봇 청소기의  전원 버튼(그림 F-8)을 표시등이 꺼질 때까지 길게 누르거나, 리모컨의  전원 끄기 버튼(그림 G-1)을 누릅니다.

유의사항: 우측 및 좌측 배터리 표시등의 상태가 모두  또는  인 경우는 자동 켜짐 타이머가 작동하지 않고 청소가 자동으로 시작되지 않을 수 있습니다.

유의사항: 이 모드에서는 청소 동작의 시작 또는 설정 변경을 수행할 수 없습니다.

유의사항: 배터리가 완전히 방전되면 자동 켜짐 타이머 설정이 지워집니다.

로봇 청소기를 특정 구역으로 제한하기

적외선 센서를 사용하는 경계 인식 기능과 경계 테이프(그림 L-1)를 사용하면, 로봇 청소기가 다음과 같은 구역을 피하도록 할 수 있습니다(그림 L-2).

- 바닥이 너무 넓어서 로봇 청소기가 한 번에 청소할 수 없기 때문에 구획으로 나눈 곳
- 로봇 청소기가 손상될 수 있는 파편들이 있는 곳
- 물건이나 가구, 장애물이 많거나 모양이 복잡하여 로봇 청소기가 걸릴 수 있는 곳
- 계단 근처
- 로봇 청소기가 올라가서 아래로 떨어지거나 로봇 청소기가 걸릴 수 있는 낮은 벽이 있는 곳

준비

1. 경계 테이프를 부착할 편평한 바닥면을 선택한 후 청소합니다.
2. 짧은 막대가 있는 쪽이 청소할 부분을 향하도록 하고 테이프와 바닥 사이에 공기 방울이 없도록 주의하며 경계 테이프를 부착합니다.

유의사항: 순정품 경계 테이프만 사용하십시오. 순정품이 아닌 테이프를 사용하면 경계 감지 기능이 오작동할 수 있습니다.

유의사항: 잘못된 감지를 유발할 수 있는 편평하지 않은 면 또는 테이프가 오염되거나 손상될 수 있는 면에는 경계 테이프를 부착하지 마십시오.

유의사항: 경계 테이프를 제거할 때 바닥이 손상되거나 소량의 접착 성분이나 바닥에 남을 수 있습니다.

유의사항: 경계 테이프를 항상 깨끗하게 유지하고, 찢어지거나 말린 부분이 없는지 확인하십시오. 테이프가 손상된 경우 교체하십시오.

 **경고:** 로봇 청소기가 진입하면 사고가 발생하거나 로봇 청소기가 낙하할 수 있는 곳에는 경계 테이프를 부착하지 마십시오. 이러한 경우에는 경계 테이프 대신, 높이가 15cm 이상이며 로봇 청소기가 부딪쳐도 넘어지지 않을 정도로 무거운 물체를 두십시오.

작동

대기 모드에서 로봇 청소기의  경계 센서 버튼(그림 F-11)을 눌러 경계 센서를 켭니다(그림 O-2). 램프(그림 F-11)가 켜집니다.

경계 센서를 해제하려면  경계 센서 버튼을 다시 누릅니다.

유의사항: 자동 켜짐 타이머가 켜져 있는 슬립 모드에서는 이 설정이 불가능합니다.

유지 보수

⚠주의: 점검 또는 유지 보수 작업을 하기 전에는 항상 두 배터리 카트리지를 모두 제거했는지 확인하십시오.

유의사항: 메인 브러시 구멍에서 먼지가 떨어지는 것을 방지하기 위해, 로봇 청소기를 뒤집을 때는 먼저 먼지통 상자를 꺼내십시오.

유의사항: 바닥과 로봇 청소기의 손상을 방지하기 위해 러그나 기타 완충재를 바닥에 가십시오(그림 B).

유의사항: 뜨거운 물(40°C 이상), 휘발유, 벤진, 신너, 알코올 등을 사용하지 마십시오. 변색 또는 변형되거나 곰이 갈 수 있습니다.

제품의 안전과 신뢰성을 유지하기 위해, 수리 및 기타 유지 보수 또는 조정 시에는 항상 Makita 순정 부품을 사용하는 Makita 공인 서비스 센터나 공장 서비스 센터를 이용하여 주십시오.

측면 브러시(그림 A, M-1) 청소

- 측면 브러시의 털에 머리카락이나 실이 낀 경우 브러시 회전이 멈출 수 있습니다. 핀셋 등으로 이를 제거하십시오.
- 브러시 털이 손상되었거나 빠진 경우에는 여분 브러시로 교체하십시오(자세한 내용은 “측면 브러시 설치” 참조).

휠 청소

- 핀셋과 가위 등의 도구를 이용하여 구동 휠(그림 M-2)의 실이나 머리카락 등을 제거합니다. 이 휠이 회전해야 효과적으로 청소됩니다.
- 핀셋, 가위 또는 비슷한 도구를 사용하여 회전 휠(그림 M-3)에서 실이나 머리카락 등을 제거합니다.

유의사항: 휠과 로봇 청소기 본체 사이에 손가락이 끼지 않도록 주의하십시오.

메인 브러시 청소

측면 브러시를 제거하면(자세한 내용은 “측면 브러시 설치” 참조) 다음 작업이 용이합니다.

- 네 개의 나사(그림 N-1)를 제거한 다음 바닥판(그림 N-2)과 메인 브러시(그림 N-3)를 제거합니다.
- 중성 세제를 조금 적신 천으로 바닥판(그림 N-2)을 닦아내고 필요한 경우 판을 물로 세척합니다.
- 가위를 사용하여 메인 브러시(그림 N-3)의 실이나 머리카락을 제거하고 필요한 경우 메인 브러시를 물로 세척합니다.
- 중성 세제를 살짝 적신 천으로 진공 구멍(그림 N-4) 안쪽을 닦아냅니다.
- 메인 브러시를 다시 장착하려면 메인 브러시 우측의 돌출부(그림 N-5)를 우측 샤프트 부시의 톱니 모양으로 들어간 부분(그림 N-6)에 맞춘 다음 메인 브러시를 삽입하여 함께 결합합니다.
- 메인 브러시의 좌측 사각 끝부분(그림 N-7)을 좌측 사각 샤프트 부시(그림 N-8)에 삽입합니다.
- 바닥판을 역순으로 다시 장착합니다.

주석: 측면 브러시가 로봇 청소기 본체에 부착되어 있을 때는, 판과 로봇 청소기 본체 사이 측면 브러시의 털을 잡아당기지 않고 측면 브러시를 수동으로 돌리면서 바닥판 부착이 용이합니다.

센서 청소

- 낙차 센서(그림 O-1) 및 경계 센서(그림 O-2)를 깨끗한 마른 면봉으로 청소합니다.
- 초음파 센서(그림 P-1)를 다른 진공 청소기의 약한 흡입 모드를 사용하여 청소합니다. 범퍼의 양쪽과 전면에 총 8개의 센서가 있습니다(그림 P-2).

필터 및 먼지통 상자 청소

유의사항: 상단 먼지통 상자 뚜껑의 손상을 막기 위해 강제로 열거나 닫지 마십시오.

- 두 잠금 장치를 풀고(그림 Q-1) 필터 관리 표시(그림 Q-2)를 잡은 채 상단 먼지통 상자 뚜껑을 들어올려 필터 격실을 엽니다.
- 필터를 꺼낸 다음(그림 Q-3) 쓰레기 봉투에 대고 털거나 바닥에 종이를 깔고 털어서 먼지를 제거합니다.

유의사항: 필터를 비비거나 비틀어 찌지 말고 날카로운 물체로 청소하지 마십시오.

- 로봇 청소기의 흡입력이 약해진 경우에는 필터를 세척합니다.

유의사항: 필터에서 냄새가 나는 경우 가정용 포백제를 희석한 용액(물 1리터에 표백제 10밀리리터)에 필터를 3시간 정도 담가두었다가 흐르는 물로 씻으십시오.

- 먼지통 상자를 세척합니다.
- 불쾌한 냄새 또는 오작동을 방지하기 위해, 필터 및 먼지통 상자를 환기가 잘 되는 곳에서 하루 동안 말립니다(물로 세척한 경우).

유의사항: 젖은 필터를 헤어 드라이어나 기타 전열 기구로 말리지 마십시오.

- 필터를 먼지통 상자에 역순으로 조립합니다.

유의사항: 격실의 필터를 교환할 때는 필터의 탭(그림 Q-4)을 필터 홀더(그림 Q-5) 가장자리의 절단면에 맞춥니다.

본체 청소

1. 중성 세제를 살짝 적신 천으로 로봇 청소기의 외장을 닦아냅니다.
2. 상단 뚜껑(그림 K-1)을 눌렀다 떼어서 잠금을 해제한 다음 완전히 개방합니다.
3. 먼지통 상자(그림 K-2)를 꺼냅니다.
4. 중성 세제를 살짝 적신 천으로 구멍 망(그림 R-2)을 포함하여 로봇 청소기의 내장(그림 R-1)을 아합니다.

로봇 청소기 복구

구동 휠이 내려가거나 배터리 전력이 소진되는 등의 상황에서 로봇 청소기가 계속 작동할 수 없는 경우, 로봇 청소기는 청소를 멈추고 다음의 램프 및 부저음을 통해 문제를 알립니다.

- 문제 해결 램프(그림 F-2)
- 필터 관리 램프(그림 F-3)
- 브러시 관리 램프(그림 F-4)
- 타이머 램프(그림 F-6)
- 부저 램프(그림 F-9)
- 진공 램프(그림 F-10)
- 경계 센서 램프(그림 F-11)

1. 다음 표를 사용하여 문제를 확인합니다.
2. 문제를 해결합니다.
3. 로봇 청소기의 전원 버튼(그림 F-8) 또는 리모컨의 시작/중지 버튼(그림 G-2)을 눌러 대기 모드에 들어갑니다.
오류 표시가 멈추고 로봇 청소기가 청소를 시작할 준비가 됩니다.

유의사항: 오류가 다시 발생하면 로봇 청소기 전원을 껐다 켜십시오.

유의사항: 교정 조치 후에도 문제가 지속되면 Makita 서비스 센터에 문의하십시오.

표시	원인/해결 방법
램프가 1번, 2번 또는 6번씩 깜박임	<ul style="list-style-type: none"> • 구동 휠이 내려갔습니다. • 로봇 청소기가 벽에 걸렸었습니다. • 로봇 청소기가 직사 광선에 노출되었습니다. • 로봇 청소기가 검은색 바닥에서 멈췄습니다. <p>→ 로봇 청소기를 다른 곳으로 옮깁니다. → 오류가 다시 발생하면 낙차 센서(그림 O-1)를 청소합니다.</p>
램프가 3번씩 깜박임	<ul style="list-style-type: none"> • 범퍼 센서 오류가 발생했습니다. <p>→ 범퍼(그림 P-2)를 10번 누릅니다.</p>
램프가 4번씩 깜박임	<ul style="list-style-type: none"> • 구동 휠에 실이나 머리카락이 끼었습니다. <p>→ 구동 휠(그림 M-2)에서 이를 제거합니다.</p> <ul style="list-style-type: none"> • 로봇 청소기가 상단면이 아래로 열리는 좁은 영역을 통과했습니다. <p>→ 이는 고장이 아닙니다.</p>

램프가 5번 또는 7번씩 깜박임	<ul style="list-style-type: none"> • 로봇 청소기가 과열되었습니다. <p>→ 로봇 청소기를 끄고 배터리 카드리를 분리한 후 1시간 동안 기다립니다. 실내 온도가 40℃를 넘지 않을 때만 로봇 청소기를 사용하십시오.</p>
및 램프가 한 번씩 깜박임	<ul style="list-style-type: none"> • 먼지통 상자나 필터가 설치되지 않았습니다. <p>→ 먼지통이나 필터를 설치합니다.</p>
및 모든 램프가 한 번씩 깜박임	<ul style="list-style-type: none"> • 배터리 충전량이 낮아서 (또는) 청소를 시작할 수 없습니다. <p>→ 배터리 카드리를 완전히 충전하십시오.</p>
및 램프가 켜짐	<ul style="list-style-type: none"> • 구동 휠에 실이나 머리카락이 끼었습니다. <p>→ 구동 휠(그림 M-2)에서 이를 제거합니다.</p> <ul style="list-style-type: none"> • 로봇 청소기가 상단면이 아래로 열리는 좁은 영역을 통과했습니다. <p>→ 이는 고장이 아닙니다.</p>
및 램프가 켜짐	<ul style="list-style-type: none"> • 센서 오류가 발생했습니다. <p>→ 로봇 청소기를 껐다 켜니다.</p>
및 램프가 켜짐	<ul style="list-style-type: none"> • 로봇 청소기에서 오류가 발생했습니다. <p>→ 로봇 청소기를 껐다 켜니다.</p>
램프가 한 번씩 깜박임	<ul style="list-style-type: none"> • 측면 브러시 및 메인 브러시에 실이나 머리카락이 끼었습니다. <p>→ 브러시(그림 A, N-3)에서 이를 제거합니다.</p>
램프가 켜짐	<ul style="list-style-type: none"> • 먼지통 상자가 먼지로 가득차거나 필터가 막혔습니다. <p>→ 먼지통 상자(그림 K-2)를 비우고 필터(그림 K-5)를 청소합니다.</p>

문제 해결

주석: 교정 조치 후에도 문제가 지속되면 Makita 서비스 센터에 문의하십시오.

증상	원인/해결 방법
▶ 버튼을 눌러도 램프가 켜지지 않습니다. 로봇 청소기 또는 리모컨의 버튼을 눌러도 로봇 청소기가 작동하지 않습니다.	<ul style="list-style-type: none"> ▶ 배터리 카트리지를 올바르게 설치하십시오. ▶ 배터리 카트리지를 완전히 충전하십시오. ▶ ▶ 버튼을 눌러 로봇 청소기 전원을 켜십시오.
로봇 청소기가 작동하지 않습니다.	<ul style="list-style-type: none"> ▶ ⚠ 문제 해결 램프, 🗑️ 필터 관리 램프 또는 ✨ 브러시 관리 램프가 켜지거나 깜박이는 경우에는 "로봇 청소기 복구"를 참조하여 문제를 해결하십시오. ▶ 파일럿 램프가 천천히 깜박이는 경우에는 모든 표시등이 꺼질 때까지 로봇 청소기의 ▶ 전원 버튼을 길게 누르거나 리모컨의 ⏻ 전원 끄기 버튼을 눌러 타이머를 지우십시오.
로봇 청소기가 자동으로 작동을 시작합니다.	<ul style="list-style-type: none"> • 자동 켜짐 타이머가 켜졌습니다.
청소 도중 로봇 청소기가 작동을 멈춥니다.	<ul style="list-style-type: none"> ▶ 로봇 청소기를 끄고 구동 휠에 붙은 줄, 끈 등을 모두 제거합니다. ▶ 로봇 청소기가 벽이나 다른 장애물에 걸린 경우 로봇 청소기를 다른 곳으로 옮깁니다.
이동 속도가 일정하지 않습니다.	<ul style="list-style-type: none"> • 로봇 청소기는 장애물이 감지되면 이동 거리를 계산하기 위해 속도를 늦춥니다. 이는 로봇 청소기의 오작동이 아닙니다.
로봇 청소기가 앞으로 똑바로 이동하지 않습니다.	<ul style="list-style-type: none"> ▶ 로봇 청소기를 끄고 구동 휠에 얽힌 이물질들을 모두 제거합니다. ▶ 초음파 센서를 청소합니다.
로봇 청소기가 전보다 자주 장애물에 부딪힙니다.	<ul style="list-style-type: none"> ▶ 초음파 센서를 청소합니다.
로봇 청소기가 계단이나 아래 바닥으로 떨어집니다.	<ul style="list-style-type: none"> ▶ 낙차 센서를 청소합니다. • 로봇 청소기는 5.5cm 이하의 높이 차이는 피하지 못할 수 있습니다. 이는 로봇 청소기의 오작동이 아닙니다.
작동 소리가 평소보다 큼니다.	<ul style="list-style-type: none"> ▶ 먼지통 상자를 비우고 필터, 측면 브러시 및 메인 브러시를 청소합니다.
흡입력이 약해서 먼지를 빨아들이지 못합니다.	<ul style="list-style-type: none"> ▶ 먼지통 상자를 비우고 필터를 청소합니다. ▶ 로봇 청소기나 리모컨의 ✨ 진공 버튼을 눌러 진공 팬을 켭니다.
측면 브러시가 떨어집니다.	<ul style="list-style-type: none"> ▶ 측면 브러시를 올바르게 설치합니다 (그림 A).
측면 브러시가 회전하지 않거나 제대로 회전하지 않습니다.	<ul style="list-style-type: none"> ▶ 측면 브러시와 메인 브러시를 청소합니다. ▶ 메인 브러시와 판을 올바르게 설치합니다(그림 N).
배출되는 공기에서 냄새가 납니다.	<ul style="list-style-type: none"> ▶ 먼지통 상자를 비우고 필터를 청소합니다.

리모컨이 작동하지 않습니다.	<ul style="list-style-type: none"> ▶ 리모컨 배터리를 올바르게 설치합니다 (그림 E). ▶ 배터리를 새 것으로 교환합니다. ▶ 로봇 청소기의 ▶ 전원 버튼을 눌러서 켭니다. ▶ 로봇 청소기에 더 가깝게 가거나 로봇 청소기와 리모컨 사이의 장애물을 제거합니다. ▶ 2.4GHz 대역의 무선 주파수를 사용하는 장비(전자렌지, Bluetooth 장치, Wi-Fi 장치 등) 근처에서 로봇 청소기 사용을 중지하거나 멀리 떨어뜨립니다. ▶ 로봇 청소기를 껐다 켭니다.
자동 켜짐 타이머가 작동하지 않습니다.	<ul style="list-style-type: none"> ▶ 완전히 충전된 배터리 카트리지를 사용합니다. ▶ 자동 켜짐 타이머를 다시 켭니다.

별매 부속품

⚠ 주의: 본 설명서에 명시된 Makita 공구에 사용하도록 권장하는 부속품 또는 장착품입니다. 다른 부속품 또는 장착품을 사용하면 부상이 발생할 수 있습니다. 부속품 또는 장착품은 지정된 용도로만 사용하여 주십시오.

- 경계 테이프
- 측면 브러시
- 메인 브러시
- 바닥판
- 필터
- Makita 정품 배터리 및 충전기

주석: 목록의 몇 가지 품목은 표준 부속품으로 공구 포장에 포함되어 있습니다. 포함된 품목은 국가별로 상이할 수 있습니다.

참조 정보

Makita Corporation 및 자회사, 계열사 및 유통사는 유지 보수 및 수리와 같은 AS 서비스의 목적으로 사용 정보를 이용할 수 있습니다. 사용 정보는 작동 횟수, 부하 배분, 오류 정보, 작동 상태 및/또는 전동 공구의 유지 보수 기록으로 구성됩니다.

A급 기기 (업무용 방송통신기자재)

이 기기는 업무용(A급) 전자파적합기기로서 판매자 또는 사용자는 이 점을 주의하시기 바라며, 가정외의 지역에서 사용하는 것을 목적으로 합니다.

- 해당 무선설비는 운용 중 전파혼신 가능성이 있음
- 해당 무선설비는 전파혼신 가능성이 있으므로 인명안전과 관련된 서비스는 할 수 없습니다

BAHASA INDONESIA (Petunjuk awal)

PERINGATAN: Mesin ini tidak ditujukan untuk digunakan oleh orang (termasuk anak) yang memiliki kekurangan fisik, pancaindra, atau mental, atau kurang memiliki pengalaman dan pengetahuan. Anak-anak harus diawasi untuk memastikan mereka tidak bermain dengan alat ini.

SPEKIFIKASI

Kartrid baterai standar	BL1815N, BL1820B, BL1830B, BL1840B, BL1850B, BL1860B
Masa pakai baterai (menggunakan baterai lithium ion opsional)	Sekitar 120 menit menggunakan dua BL1830 (masing-masing 18 V, 3 Ah) Sekitar 200 menit menggunakan dua BL1850 (masing-masing 18 V, 5 Ah)
Kapasitas wadah	2,5 L
Dimensi (p/l/t) (termasuk baterai BL1830)	Sekitar 460 x 460 x 180 mm
Berat (termasuk dua baterai BL1830)	Sekitar 7,8 kg

- Spesifikasi ini dapat berubah tanpa pemberitahuan sebelumnya karena kami masih terus menjalankan program riset dan pengembangan.
- Spesifikasi dapat berbeda di setiap negara.

Simbol



Baca buku petunjuk.



Jangan injak dan jangan letakkan benda di atas Robot Pembersih.



Jangan gunakan Robot Pembersih di dekat api maupun material yang mudah terbakar dan/atau berbahaya.



Bersihkan sensor tepi di bagian depan bawah jika kotor atau basah.

Penggunaan yang dimaksudkan

Robot Pembersih ini dimaksudkan untuk membersihkan lantai dalam ruangan. Remote control tersambung ke Robot Pembersih secara nirkabel (ZigBee 2,4 GHz).

PETUNJUK KESELAMATAN

⚠ PERINGATAN

Jangan gunakan Robot Pembersih di dekat zat yang mudah terbakar atau memvakum zat yang mudah terbakar.

Hal ini dapat menimbulkan ledakan atau kebakaran.

- Minyak tanah, minyak gas, dupa, lilin
- Bensin, tiner
- Puntung rokok
- Toner atau zat yang mudah terbakar
- Pembersih karpet atau zat berbusa lainnya

Jangan gunakan Robot Pembersih di lokasi yang basah, lokasi yang dapat menjadi basah, atau lokasi dengan suhu dan kelembapan tinggi. Selain itu, jangan vakum air.

Hal ini dapat menimbulkan sengatan listrik, hubungan arus pendek, api, perubahan bentuk, atau kegagalan fungsi.

- Dapur atau area lainnya yang menggunakan air
- Kamar mandi
- Ruang pancuran
- Loteng, dll.

Jangan sentuh Robot Pembersih dengan tangan yang basah.

Hal ini dapat mengakibatkan sengatan listrik.

Jangan gunakan Robot Pembersih di sekitar kompor atau alat pemanas lainnya.

Hal ini dapat menimbulkan sengatan listrik, hubungan arus pendek, api, perubahan bentuk, atau kegagalan fungsi.

Jangan gunakan Robot Pembersih di lokasi berikut.

Hal ini dapat mengakibatkan sengatan listrik atau cedera.

- Di dekat bayi atau orang yang memiliki kekurangan fisik, pancaindra, atau mental, atau kurang memiliki pengalaman dan pengetahuan
- Di dekat hewan
- Di dekat orang banyak atau area yang ramai

Jangan biarkan anak-anak atau orang yang tidak dapat mengekspresikan keinginannya tidak diawasi atau mengoperasikan Robot Pembersih sendiri untuk menggunakan Robot Pembersih.

Hal ini dapat mengakibatkan sengatan listrik atau cedera.

Segera hentikan pengoperasian jika terjadi kelainan atau gangguan fungsi seperti berikut.

Tidak mengikuti petunjuk ini dapat menimbulkan asap, kebakaran, atau sengatan listrik.

- Robot Pembersih tidak beroperasi meskipun telah dihidupkan.
- Robot Pembersih berubah bentuk atau panas secara abnormal.
- Robot Pembersih kadang terhenti selama pengoperasian.
- Robot Pembersih mengeluarkan bunyi abnormal selama pengoperasian.
- Robot Pembersih mengeluarkan bau terbakar.

Matikan Robot Pembersih di lokasi yang melarang penggunaannya.

Tidak mengikuti petunjuk ini dapat menyebabkan peralatan medis tidak beroperasi sebagaimana mestinya.

Pastikan untuk mengikuti petunjuk dari masing-masing lembaga medis saat menggunakan peralatan yang memancarkan gelombang radio di dalam lembaga medis.

Jangan gunakan Pembersih Robotik di dekat atau berbatasan langsung dengan ketinggian.

Hal ini dapat menyebabkan Robot Pembersih jatuh dari area, sehingga mengakibatkan cedera atau kerusakan.

- Tangga
- Di atas meja, rak, lemari pakaian, lemari es, dll.
- Mezzanine, loteng, lantai dengan sambungan langsung ke anak tangga atau jalan masuk, dll.
- Lokasi dengan kemiringan 10° atau lebih

Jangan biarkan Robot Pembersih terkena sinar matahari langsung atau sinar inframerah.

Pengoperasian yang tidak benar karena kesalahan sensor dapat menyebabkan Robot Pembersih terjatuh, sehingga mengakibatkan cedera atau kerusakan.

- Pemanas halogen
- Remote control atau sensor, dll.
- Sinar matahari yang menembus kaca buram

Pindahkan benda yang dapat menyebabkan kecelakaan jika terjadi kontak dengan Robot Pembersih.

Tidak mengikuti petunjuk ini dapat menimbulkan cedera akibat benda tersandung atau terjatuh.

- Lilin menyala, vas, dll.
- Elektronik dengan kontrol yang terletak dengan ketinggian yang sama dengan Robot Pembersih.

Jangan tutupi Robot Pembersih.

Hal ini dapat menimbulkan kebakaran akibat panas berlebih.

Jangan naiki atau letakkan benda berat pada Robot Pembersih. Jangan sampai terkena benturan keras.

Hal ini dapat mengakibatkan cedera, kerusakan, atau gangguan fungsi.

Secara khusus, perhatikan anak-anak di sekitar Robot Pembersih.

Jangan modifikasi Robot Pembersih.

Hal ini dapat mengakibatkan kebakaran, sengatan listrik, atau cedera.

Hubungi dealer tempat Anda membeli Robot Pembersih untuk diperbaiki.

Jangan halangi atau jangan masukkan benda logam atau benda asing yang mudah terbakar ke dalam lubang isap atau saluran buang. Jangan juga gunakan Robot Pembersih di sekitar benda yang dapat menghalangi lubang isap.

Hal ini dapat menimbulkan sengatan listrik, kebakaran, atau gangguan fungsi.

Jangan panaskan atau biarkan Robot Pembersih terkena api atau diletakkan di tempat yang panas, misalnya di dekat nyala api atau kompor, terkena sinar matahari langsung, atau di dalam kendaraan di bawah terik matahari.

Hal ini dapat menyebabkan hubungan arus pendek, kebakaran, atau bocornya cairan atau meledaknya baterai.

Jangan cuci atau jangan biarkan Robot Pembersih* terkena air atau deterjen.

Hal ini dapat mengakibatkan sengatan listrik, hubungan arus pendek, atau kebakaran.

- * Tidak termasuk sikat utama, pelat bawah, sikat sisi, kotak debu, dan filter

Jangan sentuh roda penggerak atau masukkan tangan maupun kaki ke bagian bawah Robot Pembersih selama pengoperasian.

Hal tersebut dapat mengakibatkan cedera.

Secara khusus, perhatikan anak-anak di sekitar Robot Pembersih.

Jangan halangi atau masukkan benda asing ke dalam sensor Robot Pembersih.

Hal ini dapat menyebabkan kegagalan pengoperasian, cedera karena Robot Pembersih jatuh sebagai akibat pengoperasian yang tidak benar, atau gangguan fungsi.

Jangan pasang selotip pada sensor atau roda. Jangan ubah bumper atau bentuk roda atau jangan tekan bumper dengan kuat.

Hal ini dapat menyebabkan kegagalan pengoperasian, cedera karena Robot Pembersih jatuh sebagai akibat pengoperasian yang tidak benar, atau gangguan fungsi.

Bersihkan setiap sensor secara berkala.

Tidak mengikuti petunjuk ini dapat menyebabkan kegagalan pengoperasian, cedera karena Robot Pembersih jatuh sebagai akibat pengoperasian yang tidak benar, atau gangguan fungsi.

Jangan gunakan pita pembatas (dijual terpisah) yang kotor, terkelupas, atau robek.

Hal ini dapat menyebabkan cedera karena Robot Pembersih jatuh sebagai akibat gagalnya pengoperasian.



Jangan gunakan Robot Pembersih di lokasi berikut.

Hal ini dapat menyebabkan peralatan lain tidak beroperasi sebagaimana mestinya.

- Di dalam rumah sakit atau di sekitar peralatan medis
- Di dalam pesawat
- Di sekitar peralatan elektronik yang memerlukan kontrol presisi atau menggunakan sinyal yang lemah.

Pastikan Robot Pembersih dan remote control berjarak lebih dari 15 cm dari alat pacu jantung implan dan defibrilator.

Tidak mengikuti petunjuk ini dapat menimbulkan gangguan fungsi pada peralatan medis.

Jangan masukkan benda asing ke dalam celah dan lubang.

Hal ini dapat mengakibatkan sengatan listrik atau cedera.

Hati-hati, jangan sampai jari Anda tersangkut saat membersihkan Robot Pembersih.

Hal tersebut dapat mengakibatkan cedera.

Pastikan untuk membaca PANDUAN PENGGUNA ini dengan cermat sebelum menggunakan Robot Pembersih.

Tidak mengikuti petunjuk ini dapat menyebabkan cedera atau kegagalan fungsi.

PEMBERITAHUAN

Segera hentikan penggunaan kartrid baterai jika ada bau tidak enak, kebocoran baterai, panas abnormal, perubahan bentuk, atau perubahan warna.

Tidak mengikuti petunjuk ini dapat mengakibatkan kegagalan fungsi.

Jangan gunakan Robot Pembersih di luar ruangan atau di lokasi yang memungkinkannya keluar dari ruangan.

Hal ini dapat mengakibatkan gangguan fungsi.

Jangan gunakan Robot Pembersih di lokasi berikut. Hal ini dapat mengakibatkan gangguan fungsi.

- Lokasi yang menahan partikel minyak goreng atau komponen minyak lainnya di udara
- Lokasi yang terdapat penggunaan semprotan aerosol atau produk kimia, seperti tempat cukur rambut, salon kecantikan, dan toko dry cleaning
- Lokasi berdebu

Jangan gunakan Robot Pembersih di lokasi berikut.

Hal ini dapat merusak lapisan lantai atau menggores permukaan lantai.

- Lokasi dengan lapisan lantai mudah rusak (kulit domba, bahan bulu, dll.)
- Lantai kayu atau marmer yang belum selesai
- Lantai yang baru dililin

Jangan gunakan Robot Pembersih pada lapisan lantai dengan tumpukan panjang (7 mm atau lebih).

Hal ini dapat menyebabkan kerusakan pada lapisan lantai atau menyebabkan gangguan fungsi Robot Pembersih.

Jangan gunakan Robot Pembersih pada permukaan lantai yang keras dan tidak rata, seperti lantai beton, dll.

Hal ini dapat menyebabkan meningkatnya sikat dan roda yang aus.

Jangan gunakan Robot Pembersih jika sikat atau roda mengalami keausan.

Hal ini dapat menyebabkan tergoresnya permukaan lantai.

Hentikan pengoperasian dan hubungi dealer tempat Anda membeli Robot Pembersih.

Bersihkan kotoran pasir yang menempel pada sikat utama, sikat sisi, dan roda.

Tidak mengikuti petunjuk ini dapat mengakibatkan tergoresnya permukaan lantai.

Jangan vakum item berikut.

Hal ini dapat menggores atau menyumbat bagian dalam Robot Pembersih atau mengakibatkan gangguan fungsi.

- Cairan atau sampah basah
- Bahan kimia atau minyak
- Kotoran hewan
- Pasir atau serbuk dalam jumlah banyak
- Benda tajam (kaca, pisau, paku payung, dll.)
- Kertas besar atau sampah vinyl
- Kabel atau tali

Bersihkan filter setelah memvakum serbuk halus (plester, semen, kapur, dll.).

Tidak mengikuti petunjuk ini dapat mengakibatkan kegagalan fungsi.

Jangan gunakan Robot Pembersih jika filter tersumbat atau sensor kotor.

Hal ini dapat mengakibatkan gangguan fungsi.

Jangan minyak sikat putar atau komponen bergerak lainnya.

Hal ini dapat menyebabkan retakan plastik.

SIMPAN PETUNJUK INI.

Penggunaan dan pemeliharaan alat baterai

1. Isi daya hanya dengan pengisi daya yang ditentukan oleh produsen. Pengisi daya yang sesuai untuk satu jenis unit baterai dapat menimbulkan risiko kebakaran bila digunakan dengan unit baterai lain.
2. Gunakan perkakas listrik hanya dengan unit baterai yang ditetapkan khusus. Penggunaan unit baterai lainnya dapat menimbulkan risiko cedera atau kebakaran.
3. Bila unit baterai tidak digunakan, jauhkan dari klip kertas, koin, kunci, paku, sekrup, dan benda logam kecil lainnya yang dapat membuat sambungan dari satu terminal ke terminal lain.
4. Jika mengalami gangguan parah, cairan dapat keluar dari baterai; hindari kontak. Jika tidak sengaja terjadi kontak, bilas dengan air.

Petunjuk keselamatan penting untuk kartrid baterai

1. Sebelum menggunakan kartrid baterai, baca semua petunjuk dan tanda tindakan pencegahan pada (1) pengisi daya baterai, (2) baterai, dan (3) produk yang menggunakan baterai.
2. Jangan bongkar kartrid baterai.
3. Jika waktu operasi menjadi lebih singkat secara signifikan daripada biasanya, segera hentikan pengoperasian. Hal ini dapat mengakibatkan risiko panas berlebih, kemungkinan luka bakar, dan bahkan ledakan.
4. Jika elektrolit masuk ke mata Anda, bilas dengan air bersih dan segera minta pertolongan medis. Hal ini dapat mengakibatkan kebutaan.
5. Jangan buat hubungan arus pendek pada kartrid baterai:
 - (1) Jangan sentuh terminal dengan materi penghantar apa pun.
 - (2) Jangan simpan kartrid baterai dalam wadah bersama benda logam lain, misalnya paku, koin, dll.
 - (3) Pastikan kartrid baterai tidak terkena air atau hujan.Arus pendek pada baterai dapat menyebabkan aliran arus besar, panas berlebih, kemungkinan luka bakar, dan bahkan kerusakan.
6. Jangan simpan Robot Pembersih dan kartrid baterai di lokasi dengan suhu yang dapat mencapai atau melebihi 50°C.
7. Jangan bakar kartrid baterai meskipun telah rusak atau benar-benar usang. Kartrid baterai dapat meledak dalam api.

8. **Hati-hati jangan sampai kartrid baterai jatuh atau terbentur.**
9. **Jangan gunakan kartrid baterai rusak.**
10. **Ikuti peraturan setempat mengenai pembuangan kartrid baterai.**

SIMPAN PETUNJUK INI.

⚠ PERHATIAN: Gunakan hanya baterai asli Makita. Penggunaan baterai Makita palsu, atau baterai yang telah diganti, dapat menyebabkan baterai meledak dan mengakibatkan kebakaran, cedera, dan kerusakan. Tindakan tersebut juga akan membatalkan jaminan Makita atas alat dan pengisi daya Makita.

Tips untuk mempertahankan masa pakai baterai maksimum

1. **Isi daya kartrid baterai sebelum benar-benar habis. Selalu hentikan pengoperasian dan isi daya kartrid baterai bila daya alat berkurang.**
2. **Jangan isi ulang daya kartrid baterai yang terisi penuh. Mengisi daya berlebihan akan mempersingkat usia baterai.**
3. **Isi daya kartrid baterai dalam suhu ruang sekitar 10°C - 40°C. Biarkan kartrid baterai panas mendingin sebelum diisi daya.**
4. **Sebaiknya isi daya kartrid baterai sebelum menyimpannya dalam waktu lama (lebih dari enam bulan).**

Sistem perlindungan alat/kartrid baterai

Robot Pembersih dilengkapi sistem perlindungan alat/kartrid baterai yang secara otomatis akan memutuskan aliran daya ke motor untuk memperpanjang masa pakai Robot Pembersih dan kartrid baterai. Robot Pembersih akan secara otomatis berhenti dalam kondisi berikut.

Kelebihan beban

Bila Robot Pembersih kelebihan beban dan menarik arus daya yang tinggi, Robot Pembersih akan secara otomatis berhenti tanpa indikasi apa pun. Untuk menghidupkan ulang Robot Pembersih, matikan daya, kurangi penyebab kelebihan beban, lalu hidupkan kembali daya.

Panas berlebih

Bila Robot Pembersih terlalu panas, lampu  akan berkedip 5 atau 7 kali untuk setiap urutan dan Robot Pembersih akan secara otomatis berhenti. Dalam kasus ini, biarkan Robot Pembersih mendingin sebelum dihidupkan kembali.













Daya benar-benar habis

Bila daya baterai yang tersisa akan habis, Robot Pembersih akan secara otomatis berhenti dan tidak akan merespons pengoperasian tombol apa pun. Dalam kasus ini, keluarkan dan isi ulang daya kartrid baterai.









TOMBOL DAN INDIKATOR

Anda dapat menemukan rincian komponen dengan mencari nomor gambar yang sesuai untuk setiap komponen dalam dokumen ini (misalnya, cari "Gambar F-8" untuk tombol **DAYA** )

Robot Pembersih (Gambar F)

1. Lampu pilot
2. Lampu Pemecahan masalah 
3. Lampu Pemeliharaan filter 
4. Lampu Pemeliharaan sikat 
5. Indikator baterai  (untuk kartrid baterai kanan dan kiri)
6. Tombol dan lampu Timer 
7. Tombol dan lampu mode Jelajah 
 - : Mode Pola
 - : Mode Acak
8. Tombol **DAYA** (mulai/berhenti) 
9. Tombol dan lampu Buzzer 
10. Tombol dan lampu Vakum 
11. Tombol dan lampu Sensor pembatas 

Remote control (Gambar G)

1. Tombol **DAYA MATI** 
2. Tombol Mulai/Berhenti 
3. Tombol Penentu lokasi 
4. Tombol mode Jelajah  / 
5. Tombol Timer 
6. Tombol Buzzer 
7. Tombol Vakum 

SEBELUM PENGGUNAAN

Perakitan dan pemasangan baterai

⚠ PERHATIAN: Pastikan untuk selalu mematikan Robot Pembersih sebelum melakukan apa pun pada Robot Pembersih.

Aksesori yang tersedia

Pastikan item dalam daftar berikut ada dalam kemasan.

- Baterai AAA (LR03) (x2)
- Sikat sisi (x4, termasuk dua sikat cadangan)
- Sekrup untuk pemasangan sikat sisi (x4)
- Pita pembatas (15 m x1)
- Panduan Pengguna (x1)
- Panduan ringkas (x1)
- Catatan tentang penggunaan (x1)

Memasang sikat sisi (Gambar A)

Pasang sikat sisi pada kedua sisi bagian depan bawah Robot Pembersih.

PEMBERITAHUAN: Sebelum melakukan sesuatu, pastikan untuk membentangkan karpet atau bantal lain guna mencegah kerusakan pada lantai dan Robot Pembersih (Gambar B).

1. Letakkan sikat sisi pada kepala poros putar pada Robot Pembersih dengan alur sikat sesuai dengan kepala poros.
2. Kencangkan sikat sisi menggunakan sekrup yang tersedia.

PEMBERITAHUAN: Pastikan jika Robot Pembersih dioperasikan dengan sikat sisi terpasang.

Memasang kartrid baterai

Sejajarkan alur (Gambar C-2) pada kartrid baterai dengan lidah (Gambar C-3) pada dok baterai dan masukkan pada tempatnya. Masukkan sepenuhnya hingga terkunci pada tempatnya dengan sedikit klik.

Jika Anda dapat melihat indikator merah (Gambar C-1) di bagian atas tombol pelepas, berarti kartrid baterai belum benar-benar terkunci.

⚠ PERHATIAN: Hati-hati saat memasang kartrid baterai, jangan sampai jari terjepit antara dok dan kartrid baterai.

Robot Pembersih dapat beroperasi hanya dengan satu kartrid baterai terpasang di salah satu dok baterai.

Untuk melepaskan kartrid baterai, geser dari dok sambil menekan tombol pelepas (Gambar D-1) pada kartrid.

Memasang baterai remote control (Gambar E)

Geser tutup tempat baterai hingga terlepas, lalu masukkan dua baterai ukuran AAA (LR03), perhatikan dan sejajarkan polaritas (+ / -) dengan benar.





PEMBERITAHUAN: Jangan gunakan baterai baru dan lama secara bersamaan, atau jangan gunakan jenis baterai yang berbeda secara bersamaan.

PEMBERITAHUAN: Lepas baterai jika remote control tidak akan digunakan untuk jangka waktu lama.

⚠ PERHATIAN: Jika kulit atau mata terkena elektrolit yang bocor dari baterai, segera bilas dengan air.

Memasang Robot Pembersih dengan remote control

Robot Pembersih telah dipasangkan dengan remote control. Namun, proses pembuatan pasangan harus dilakukan lagi jika Anda mengganti remote control.

1. Tekan terus tombol Timer  (Gambar F-6) dan mode Jelajah  (Gambar F-7) secara bersamaan pada Robot Pembersih hingga buzzer berbunyi bip dua kali.
2. Tekan terus tombol Timer  (Gambar G-5) dan Penentu lokasi  (Gambar G-3) secara bersamaan pada remote control hingga buzzer berbunyi bip satu kali.

Jika pembuatan pasangan gagal dan buzzer berbunyi bip 5 kali, coba lagi pembuatan pasangan.

Mengatur ruang

Untuk memastikan penjelajahan lancar

- Tutup pintu ke ruangan. Jika undakan batas pintu tidak terlalu besar dan dapat dilalui Robot Pembersih tanpa masalah, pintu tersebut juga dapat dibiarkan terbuka agar Robot Pembersih dapat lanjut membersihkan ruang yang bersebelahan.

- Letakkan penghalang di depan furnitur yang mudah rusak, dll.
- Letakkan penghalang untuk mencegah Robot Pembersih masuk ke lokasi yang dapat membuatnya tertahan, seperti kolong rak rendah.
- Pindahkan benda yang tinggi, tipis, dan tidak stabil serta benda lain yang mudah terjatuh ke ruangan lain.
- Kunci roda meja dorong atau benda lain, atau pindahkan ke ruangan lain.
- Atur kabel listrik di dinding.
- Pindahkan bantal, buku, atau benda lain yang dapat menghalangi Robot Pembersih menjelajah ke ruangan lain.
- Angkat bagian tirai atau benda lain yang menjuntai ke lantai.
- Pindahkan lapisan lantai dengan tali yang mudah ditarik atau berundak dan lapisan lantai yang tipis dan mudah bergeser ke ruangan lain.
- Lipat semua rumbai lapisan lantai ke bawah lapisan lantai.
- Singkirkan semua benda kecil atau mahal yang dapat tertukuk dengan mudah.
- Singkirkan semua kabel, sabuk, tali, kertas tipis, atau kantong plastik yang berserakan di lantai.
- Tarik setiap soket daya lantai yang dapat memendek sendiri.
- Tutup semua kisi pembatas bagian lantai dengan papan, dll. karena Robot Pembersih dapat mendeteksinya sebagai batas dan tidak dapat melintasinya.

Mencegah Robot Pembersih terjatuh

- Jika area yang dibersihkan memiliki anak tangga atau bagian lain yang dapat mengakibatkan Robot Pembersih terjatuh, letakkan benda dengan tinggi 15 cm atau lebih dan yang cukup berat untuk menahan Robot Pembersih di depan bagian tersebut agar Robot Pembersih tidak masuk.
- Halangi sinar matahari dan sinar inframerah dengan tirai. (Robot Pembersih dapat terjatuh ke tingkat yang lebih rendah bila mundur untuk menghindari sinar matahari atau sinar inframerah.)
- Tutup pintu aluminium. (Robot Pembersih mungkin tidak dapat mendeteksi undakan antara rel aluminium dan lantai, dan dapat terjatuh dari pintu.)
- Pindahkan lapisan lantai di dekat undakan ke ruangan lain. (Robot Pembersih mungkin tidak dapat mendeteksi undakan dan dapat terjatuh.)

CATATAN

- Jangan gunakan Robot Pembersih di dekat zat yang mudah terbakar atau memvakum zat yang mudah terbakar. (Hal ini dapat menimbulkan ledakan atau kebakaran.)
- Jangan gunakan Robot Pembersih di lokasi yang basah, lokasi yang dapat menjadi basah, atau lokasi dengan suhu dan kelembapan tinggi. Selain itu, jangan vakum air. (Hal ini dapat menimbulkan sengatan listrik, hubungan arus pendek, api, perubahan bentuk, atau kegagalan fungsi.)
- Jangan gunakan Robot Pembersih di lokasi yang berjarak sekitar 1 m atau kurang dari dinding ke undakan. (Dalam kasus yang jarang terjadi, Robot Pembersih dapat terjatuh saat mundur.)

- Jangan gunakan Robot Pembersih di area berpembatas yang tidak dapat dilintasi Robot Pembersih di sekitar dinding atau penghalang. Robot Pembersih dapat tersangkut pada pembatas saat bergerak mundur untuk menghindari dinding atau penghalang.
- Nonaktifkan sistem keamanan rumah, dll. (Robot Pembersih dapat salah terdeteksi sebagai penyusup.)
- Robot Pembersih mungkin tidak dapat menghindari undangan dengan tinggi 5,5 cm atau kurang.
- Noise mungkin akan muncul di layar TV selama pengoperasian. (Ini bukan gangguan fungsi televisi.)
- Jangan simpan Robot Pembersih untuk jangka waktu lama dengan kartrid baterai terpasang. (Elektrolit baterai dapat bocor.)
- Jangan balik Robot Pembersih dengan kartrid baterai terpasang. (Tombol dapat tertekan dan robot beroperasi secara tidak disengaja.)



PEMBERITAHUAN: Jika terjadi kondensasi, matikan Robot Pembersih dan tunggu hingga Robot Pembersih kering, sebelum memulai kembali pengoperasian.

PEMBERITAHUAN: Semua pengaturan tidak akan dihapus bila Robot Pembersih dimatikan. Pastikan untuk mengkonfirmasi bahwa pengaturan sudah benar melalui lampu (Gambar F-6, 7, 9, 11) pada Robot Pembersih untuk mencegah pengoperasian tidak terduga.

1. Tekan tombol **DAYA**  (Gambar F-8) pada Robot Pembersih.
Robot Pembersih akan beralih ke mode siaga dan indikator Baterai  (Gambar F-5) menyala. (Untuk informasi rinci, lihat "Indikator Baterai pada Robot Pembersih" di bawah ini.)
2. Tekan tombol mode Jelajah  (Gambar F-7) pada Robot Pembersih berulang kali untuk memilih mode, atau tekan tombol mode Jelajah  atau  (Gambar G-4) pada remote control.
Lampu mode yang dipilih akan menyala. (Untuk informasi rinci, lihat "Mode Jelajah" di bawah ini.)
3. Tekan tombol **DAYA**  (Gambar F-8) pada Robot Pembersih atau tombol Mulai/Berhenti  (Gambar G-2) pada remote control untuk memulai pembersihan.
Lampu pilot (Gambar F-1) akan menyala dan buzzer berbunyi sewaktu pembersihan.

Untuk menunda operasi pembersihan, ulangi langkah 3.

Untuk melanjutkan operasi pembersihan, ulangi langkah 3.





Untuk mematikan Robot Pembersih, tekan terus tombol **DAYA**  (Gambar F-8) pada Robot Pembersih hingga semua indikator **MATI**, atau tekan tombol **DAYA MATI**  (Gambar G-1) pada remote control.

PERHATIAN: Jangan terlalu dekat melihat cahaya lampu pilot, atau hindari cahaya terkena mata. Hal tersebut akan membahayakan mata.

Indikator baterai pada Robot Pembersih

Indikator baterai yang terletak pada sisi kartrid baterai yang sesuai akan menyala dan menunjukkan daya kartrid baterai yang tersisa.

PEMBERITAHUAN: Tabel berikut berisi indikasi kasar daya baterai yang tersisa. Jumlah tersisa dapat beragam, tergantung pada kondisi penggunaan dan suhu ruangan.

	50% atau lebih
	Antara 20% hingga 50%
	20% atau kurang
	Kosong/Kartrid baterai tidak dipasang
	Kesalahan pada baterai

PENGOPERASIAN

Robot Pembersih akan menjelajahi lantai berdasarkan mode jelajah standar, menghindari penghalang menggunakan sensor ultrasonik (Gambar P-1), serta mengisap debu dan kotoran dan sisa lainnya di jalur lintasan menggunakan sikat sisi, sikat utama, dan kipas vakum. Namun, sensor mungkin tidak mendeteksi penghalang dalam situasi tertentu. Jika Robot Pembersih mengenai penghalang, bumper Robot Pembersih (Gambar P-2) akan menahan benturan dan mengubah arah jalan.

CATATAN: Robot Pembersih mungkin sesekali tidak dapat melewati pembatas dengan tinggi maksimum 1,5 cm, meskipun Robot Pembersih didesain untuk dapat melewati pembatas tersebut.

CATATAN: Robot Pembersih mungkin akan menghindari area berwarna hitam, memiliki pola kayu hitam, atau area yang terbuat dari kaca.

CATATAN: Setelah siklus pembersihan selesai, debu dan kotoran tertentu dapat menempel dalam kondisi tertentu.

CATATAN: Komunikasi nirkabel dapat terganggu atau terblokir dalam kondisi berikut:

- Di dalam bangunan berbahan beton kuat dan logam
- Bila Robot Pembersih di belakang penghalang
- Di dekat peralatan komunikasi radio yang menggunakan pita frekuensi yang sama
- Di dekat perangkat yang menghasilkan medan elektromagnet (oven microwave, dll.) atau listrik statis, atau yang menyebabkan interferensi gelombang radio

Pengoperasian dasar







PERHATIAN: Pastikan selalu Robot Pembersih dimatikan sebelum menyesuaikan atau memeriksa fungsi pada Robot Pembersih.

Indikator baterai pada kartrid baterai



Daya yang tersisa juga dapat diperiksa menggunakan indikator baterai (Gambar I-1) pada kartrid baterai dengan nomor model yang berakhiran "B".

Lepas kartrid baterai, lalu tekan tombol  (Gambar I-2).

PEMBERITAHUAN: Tabel berikut berisi indikasi kasar daya baterai yang tersisa. Jumlah tersisa dapat beragam, tergantung pada kondisi penggunaan dan suhu ruangan.

	75% atau lebih
	Antara 50% hingga 75% (termasuk 50%)
	Antara 25% hingga 50%
	25% atau kurang
	Kosong
	Kesalahan pada baterai

Mode Jelajah

Mode Pola 	Aplikasi: Lantai luas dengan sedikit penghalang seperti dalam gudang yang tertata rapi dan galeri panjang. Deskripsi (Gambar H-1): Robot Pembersih akan mengulang siklus jalan vertikal (a) dan horizontal (b).*
Mode Acak 	Aplikasi: Lantai dengan banyak penghalang, misalnya kantor. Deskripsi (Gambar H-2): Robot Pembersih akan mengulang siklus jalan benturan (c) dan sepanjang dinding (d).

* Berdasarkan kondisi yang dialami, jejak sebenarnya Robot Pembersih dapat berbeda dari tabel ini.

CATATAN: Robot Pembersih tidak dapat membersihkan ruangan sempit yang tidak memungkinkan Robot Pembersih berjalan atau tidak dapat dijangkau sikat sisi.

CATATAN: Setelah siklus pembersihan selesai, debu tertentu dapat menempel di lantai dalam kondisi tertentu.

Mode Tidur

Jika dibiarkan sekitar 5 menit dalam mode siaga, Robot Pembersih akan secara otomatis beralih ke mode tidur untuk menghemat baterai, dan lampu pilot (Gambar F-1) berkedip pelan. Robot Pembersih juga akan beralih ke mode tidur bila timer hidup otomatis diaktifkan. Untuk kembali ke mode siaga, lakukan langkah 3 dalam "Pengoperasian dasar".

PEMBERITAHUAN: Perubahan pengaturan dan dimulainya operasi pembersihan tidak dapat dilakukan dalam mode ini.

Membawa Robot Pembersih

⚠ PERHATIAN: Sebelum membawa Robot Pembersih, pastikan untuk mematikan Robot Pembersih.

⚠ PERHATIAN: Hati-hati, jangan sampai tangan Anda terjepit di antara gagang dan bodi Robot Pembersih.



Pegang gagang (Gambar J-1).

PEMBERITAHUAN: Jika Anda menyangga bagian bawah belakang Robot Pembersih dengan tangan lainnya, pastikan untuk tidak mengangkat bagian tersebut terlalu tinggi karena debu dan kotoran di Robot Pembersih dapat keluar melalui celah sikat utama.

PEMBERITAHUAN: Jangan tarik Robot Pembersih.

Mengosongkan wadah

Kosongkan wadah setiap kali selesai digunakan agar Robot Pembersih tetap memiliki performa optimal.

1. Tekan terus tombol **DAYA**  (Gambar F-8) pada Robot Pembersih hingga semua indikator **MATI**, atau tekan tombol **DAYA MATI**  (Gambar G-1) pada remote control untuk mematikan Robot Pembersih.
2. Tekan, lalu lepas tutup atas (Gambar K-1) untuk membuka kunci, lalu buka tutup sepenuhnya.
3. Keluarkan kotak debu (Gambar K-2).
4. Buka kunci keduanya (Gambar K-3), lalu buka tutup kotak debu.
5. Keluarkan, lalu kosongkan wadah atas (Gambar K-4).
6. Bersihkan gumpalan kecil debu dari filter (Gambar K-5), lalu kosongkan wadah bawah (Gambar K-6).
7. Ganti kotak debu dalam Robot Pembersih dengan urutan terbalik.

Operasi lanjutan

Fitur berikut hanya dapat ditetapkan bila Robot Pembersih dalam mode siaga (lihat langkah 1 dalam "Pengoperasian dasar").

Menghemat daya

Robot Pembersih dapat mengisap debu yang jelas terlihat tanpa menggunakan kipas vakum. Jika tidak perlu membersihkan debu halus, mematikan kipas vakum akan menghemat daya baterai untuk memperpanjang waktu pengoperasian Robot Pembersih.

Dalam mode siaga, tekan tombol **Vakum**  pada Robot Pembersih (Gambar F-10) atau pada remote control (Gambar G-7) untuk mematikan lampu Vakum (Gambar F-10).

Untuk menghidupkan kipas vakum, tekan tombol **Vakum**  pada Robot Pembersih (Gambar F-10) atau pada remote control (Gambar G-7). Lampu akan menyala kembali.

PEMBERITAHUAN: Pengaturan ini tidak dapat dilakukan dalam mode tidur dengan timer hidup otomatis diaktifkan.

PEMBERITAHUAN: Pada saat kipas pengisap debu TIDAK AKTIF, lampu pemeliharaan Filter (Gbr. F-3) tidak menyala meskipun filter dipenuhi kotoran.

Mengatur volume suara buzzer

Tiga tingkat volume suara buzzer termasuk senyap dapat dipilih.

Dalam mode siaga, tekan tombol Buzzer  berulang kali pada Robot Pembersih (Gambar F-9) atau pada remote control (Gambar G-6). Setiap kali Anda menekan tombol, buzzer akan berbunyi dalam urutan berikut: volume tinggi (lampu menyala), volume rendah (lampu menyala), lalu tanpa suara (lampu mati).

PEMBERITAHUAN: Pengaturan ini tidak dapat dilakukan dalam mode tidur dengan timer hidup otomatis diaktifkan.

Mencari Robot Pembersih

Fitur ini berguna untuk menemukan Robot Pembersih yang mungkin tidak terlihat di lantai luas yang dipenuhi meja, kabinet, atau perlengkapan lainnya.

Tekan tombol Penentu lokasi  pada remote control (Gambar G-3) sewaktu Robot Pembersih dalam mode siaga atau tidur. Buzzer akan berbunyi sekitar 10 detik dan lampu pilot akan berkedip.

Untuk menghentikan buzzer dan mematikan lampu, tekan kembali tombol Penentu lokasi .





CATATAN: Robot Pembersih mungkin sesekali tidak merespons karena berada di luar jangkauan remote control. Masalah dapat diatasi dengan menekan tombol Penentu lokasi  sambil Anda bergerak.

Menggunakan timer hidup otomatis



Fitur ini memungkinkan Robot Pembersih memulai pembersihan secara otomatis setelah waktu yang ditentukan.



Karena pengaturan akan dihapus setelah pembersihan waktu otomatis selesai, maka lakukan prosedur berikut untuk mengaktifkan kembali timer hidup otomatis.

1. Dalam mode siaga, tekan tombol Timer  berulang kali pada Robot Pembersih (Gambar F-6) atau pada remote control (Gambar G-5). Setiap kali Anda menekan tombol, pengaturan akan berubah dalam urutan berikut:

Status lampu	Pembersihan dimulai
	setelah 1 jam.
	setelah 3 jam.
	setelah 5 jam.
	Timer hidup otomatis dinonaktifkan.

2. Tekan tombol DAYA  (Gambar F-8) pada Robot Pembersih untuk mengaktifkan timer hidup otomatis. Robot Pembersih akan beralih ke mode tidur.

Untuk menghapus timer dalam mode siaga, tekan terus tombol DAYA  (Gambar F-8) pada Robot Pembersih hingga semua indikator mati, atau tekan tombol DAYA MATI  (Gambar G-1) pada remote control.

PEMBERITAHUAN: Jika status baterai kiri dan kanan  atau , timer otomatis aktif tidak dapat diaktifkan dan pembersihan tidak dapat dimulai otomatis.

PEMBERITAHUAN: Perubahan pengaturan dan dimulainya operasi pembersihan tidak dapat dilakukan dalam mode ini.

PEMBERITAHUAN: Pengaturan timer hidup otomatis akan dihapus jika daya baterai benar-benar habis.

Membatasi Robot Pembersih pada area tertentu

Pita pembatas (Gambar L-1) dan fitur deteksi pembatas yang menggunakan sensor inframerah memungkinkan Robot Pembersih menghindari area berikut (Gambar L-2):

- Area yang terbagi dalam beberapa bagian karena keseluruhan lantai terlalu luas sehingga Robot Pembersih tidak dapat membersihkan lantai dalam sekali pengoperasian
- Area yang terdapat benda rapuh dan dapat rusak karena Robot Pembersih
- Area yang penuh dengan barang dan perlengkapan, pembatas, atau berbentuk rumit, sehingga Robot Pembersih dapat terhalang
- Area di sekitar tangga
- Area berpembatas rendah yang dapat dilewati Robot Pembersih dan jatuh ke lantai yang lebih rendah, atau yang akan membuat Robot Pembersih terhalang

Persiapan

1. Pilih permukaan yang rata dan halus pada lantai yang akan dipasang pita pembatas, lalu bersihkan permukaan.
2. Pasang pita pembatas sehingga bagian dengan palang pendek sejajar dengan area pembersihan dan tidak ada gelembung udara di antara pita dan lantai.

PEMBERITAHUAN: Pastikan untuk hanya menggunakan pita pembatas asli. Menggunakan pita selain yang asli dapat berisiko kegagalan fungsi pada fitur deteksi pembatas.

PEMBERITAHUAN: Jangan pasang pita pembatas pada permukaan tidak rata yang dapat mengakibatkan kesalahan deteksi atau permukaan yang dapat mengotori atau merusak pita.

PEMBERITAHUAN: Perhatikan bahwa bahan perekat tertentu dapat menempel di lantai, atau lantai dapat rusak saat pita pembatas dilepas.

PEMBERITAHUAN: Pastikan pita pembatas tetap bersih dan periksa apakah ada bagian yang rusak atau robek. Ganti pita jika rusak.

⚠ PERINGATAN: Jangan pasang pita pembatas di area yang dapat mengakibatkan kecelakaan karena Robot Pembersih memasuki area tersebut atau Robot Pembersih jatuh dari area tersebut. Dalam kasus tersebut, letakkan benda dengan tinggi 15 cm atau lebih dan yang cukup berat untuk menahan benturan Robot Pembersih, sebagai pengganti pita pembatas.

Pengoperasian

Dalam mode siaga, tekan tombol Sensor pembatas  (Gambar F-11) pada Robot Pembersih untuk mengaktifkan sensor pembatas (Gambar O-2). Lampu (Gambar F-11) akan menyala.

Untuk menonaktifkan sensor pembatas, tekan kembali tombol Sensor pembatas .

PEMBERITAHUAN: Pengaturan ini tidak dapat dilakukan dalam mode tidur dengan timer hidup otomatis diaktifkan.

PEMELIHARAAN

⚠ PERHATIAN: Pastikan selalu kedua kartrid baterai dilepas sebelum melakukan pemeriksaan atau pemeliharaan.

PEMBERITAHUAN: Pastikan untuk mengeluarkan kotak debu sebelum membalik Robot Pembersih agar debu atau kotoran tidak keluar melalui celah sikat utama.

PEMBERITAHUAN: Pastikan untuk membentangkan karpet atau bantalan lainnya guna mencegah kerusakan pada lantai dan Robot Pembersih (Gambar B).

PEMBERITAHUAN: Jangan gunakan air panas (lebih dari 40°C), minyak gas, bensin, tiner, alkohol, atau semacamnya. Semua dapat mengakibatkan perubahan warna, perubahan bentuk, atau keretakan.

Untuk mempertahankan KEAMANAN dan KEANDALAN produk, perbaikan, pemeliharaan, atau penyesuaian lainnya harus dilakukan di Pusat Servis Resmi atau Pabrik Makita yang selalu menggunakan komponen pengganti Makita.

Membersihkan sikat sisi (Gambar A, M-1)

- Benang dan rambut yang tersangkut di bulu sikat sisi dapat mengakibatkan sikat berhenti berputar. Bersihkan kotoran tersebut menggunakan penjepit atau alat bantu serupa.
- Jika bulu sikat rusak atau terlepas, ganti dengan sikat cadangan (lihat "Memasang sikat sisi" untuk informasi rinci).

Membersihkan roda

- Bersihkan benang dan rambut dari roda penggerak (Gambar M-2) menggunakan alat bantu seperti penjepit dan gunting. Memutar roda akan memudahkan pembersihan.

- Bersihkan benang dan rambut dari roda putar (Gambar M-3) menggunakan penjepit, gunting, atau alat bantu serupa.

PEMBERITAHUAN: Hati-hati, jangan sampai jari terjepit di antara roda dan bodi Robot Pembersih.

Membersihkan sikat utama

Melepas sikat sisi (lihat "Memasang sikat sisi" untuk informasi rinci) akan memudahkan tugas berikut.

1. Lepas empat sekrup (Gambar N-1), lalu pelat bawah (Gambar N-2) dan sikat utama (Gambar N-3).
2. Seka pelat bawah (Gambar N-2) dengan kain yang sedikit dibasahi dengan sedikit deterjen atau cuci pelat dengan air jika perlu.
3. Bersihkan benang dan rambut dari sikat utama (Gambar N-3) menggunakan gunting, lalu cuci sikat utama dengan air jika perlu.
4. Seka bagian dalam ventilasi vakum (Gambar N-4) dengan kain yang sedikit dibasahi dengan deterjen lembut.
5. Untuk mengganti sikat utama, sejajarkan bagian yang menonjol (Gambar N-5) pada ujung kanan sikat utama dengan lekukan pada bush poros kanan (Gambar N-6), lalu masukkan sikat utama untuk memasangnya.
6. Masukkan ujung persegi kiri sikat utama (Gambar N-7) ke bush poros persegi kiri (Gambar N-8).
7. Ganti pelat bawah dengan urutan terbalik.

CATATAN: Bila sikat sisi tetap terpasang di bodi Robot Pembersih, mutar sikat sisi secara manual akan memudahkan pemasangan pelat bawah tanpa menjepit bulu sikat sisi antara pelat dan bodi Robot Pembersih.

Membersihkan sensor

- Bersihkan sensor jurang (Gambar O-1) dan sensor pembatas (Gambar O-2) menggunakan kuas kapas bersih dan kering.
- Bersihkan sensor ultrasonik (Gambar P-1) menggunakan set pembersih vakum lain dalam mode isap halus. Secara keseluruhan terdapat 8 sensor pada bagian depan dan kedua sisi bumper (Gambar P-2).

Membersihkan filter dan kotak debu

PEMBERITAHUAN: Untuk menghindari kerusakan pada tutup kotak debu atas, jangan buka atau tutup dengan paksa.

1. Buka kedua kunci (Gambar Q-1), lalu angkat tutup kotak debu bagian atas sambil menahan tanda Pemeliharaan filter  (Gambar Q-2) untuk membuka kompartemen filter.
2. Lepas filter (Gambar Q-3), lalu ketuk ke kantong sampah atau kain penampung kotoran pada permukaan rata untuk menghilangkan debu dan kotoran.

PEMBERITAHUAN: Jangan gosok atau tekan filter, atau jangan gunakan benda tajam untuk membersihkan filter.

- Cuci filter jika daya isap Robot Pembersih berkurang.

PEMBERITAHUAN: Jika filter bau, rendam filter dalam larutan pemutih encer (10 mililiter pemutih per 1 liter air) kurang lebih selama 3 jam sebelum mencuci filter di air mengalir.

- Cuci kotak debu.
- Keringkan filter (jika dicuci) dan kotak debu selama 1 hari di ruangan berventilasi baik untuk mencegah bau tidak enak atau kegagalan fungsi.

PEMBERITAHUAN: Jangan keringkan filter yang basah menggunakan pengering rambut atau sumber panas lainnya.

- Ganti filter di kotak debu dengan urutan terbalik.







PEMBERITAHUAN: Bila Anda mengganti filter dalam kompartemen, pastikan tab (Gambar Q-4) pada filter sesuai dengan lekukan pada tepi penyangga filter (Gambar Q-5).



Membersihkan bodi

- Seka bagian luar Robot Pembersih dengan kain yang sedikit dibasahi dengan deterjen lembut.
- Tekan, lalu lepas tutup atas (Gambar K-1) untuk membuka kunci, lalu buka tutup sepenuhnya.
- Keluarkan kotak debu (Gambar K-2).
- Seka bagian dalam Robot Pembersih (Gambar R-1) termasuk kisi ventilasi (Gambar R-2) dengan kain yang sedikit dibasahi dengan deterjen lembut.

MENYIMPAN ROBOT PEBERSIH



















Bila Robot Pembersih tidak dapat beroperasi dalam kondisi tertentu seperti roda penggerak menggantung atau kehabisan daya baterai, Robot Pembersih akan berhenti membersihkan dan menunjukkan kesalahan dengan lampu dan buzzer berikut.

-  Lampu Pemecahan masalah (Gambar F-2)
-  Lampu Pemeliharaan filter (Gambar F-3)
-  Lampu Pemeliharaan sikat (Gambar F-4)
-  Lampu Timer (Gambar F-6)
-  Lampu Buzzer (Gambar F-9)
-  Lampu Vakum (Gambar F-10)
-  Lampu Sensor pembatas (Gambar F-11)

- Identifikasikan masalah menggunakan tabel berikut.
- Atasi masalah.
- Tekan tombol **DAYA**  (Gambar F-8) pada Robot Pembersih atau tombol Mulai/Berhenti  (Gambar G-2) pada remote control untuk beralih ke mode siaga. Indikasi kesalahan akan berhenti dan Robot Pembersih siap membersihkan.









PEMBERITAHUAN: Jika kesalahan terjadi lagi, matikan, lalu hidupkan Robot Pembersih.

PEMBERITAHUAN: Jika masalah berlanjut setelah melakukan tindakan perbaikan, hubungi Pusat Servis Makita terdekat.

Indikasi	Penyebab/Solusi
Lampu  berkedip sekali, dua kali, atau 6 kali untuk setiap urutan	<ul style="list-style-type: none"> Roda penggerak menggantung. Robot Pembersih terhalang pembatas. Robot Pembersih terkena sinar matahari langsung. Robot Pembersih terhenti di lantai hitam. <p>→ Pindahkan Robot Pembersih dari area tersebut.</p> <p>→ Jika kesalahan berlanjut, bersihkan sensor jurang (Gambar O-1).</p>
Lampu  berkedip 3 kali untuk setiap urutan	<ul style="list-style-type: none"> Terjadi kesalahan pada sensor bumper. <p>→ Tekan bumper (Gambar P-2) 10 kali.</p>
Lampu  berkedip 4 kali untuk setiap urutan	<ul style="list-style-type: none"> Benang dan rambut tersangkut pada roda penggerak. <p>→ Bersihkan dari roda penggerak (Gambar M-2). <ul style="list-style-type: none"> Robot Pembersih melewati area berpembatas dengan permukaan bagian atasnya terdorong. <p>→ Hal ini bukan kegagalan fungsi.</p> </p>
Lampu  berkedip 5 atau 7 kali untuk setiap urutan	<ul style="list-style-type: none"> Robot Pembersih terlalu panas. <p>→ Matikan Robot Pembersih, lepas katrid baterai, lalu tunggu selama sejam. Gunakan Robot Pembersih hanya pada suhu ruang tidak lebih dari 40°C.</p>
Lampu  dan  berkedip sekali untuk setiap urutan	<ul style="list-style-type: none"> Kotak debu atau filter belum dipasang. <p>→ Pasang kotak debu atau filter.</p>
Lampu  dan semua  berkedip sekali untuk setiap urutan	<ul style="list-style-type: none"> Daya baterai yang tersisa tidak cukup ( atau ) untuk memulai pembersihan. <p>→ Isi penuh daya kartrid baterai.</p>
Lampu  dan  menyala	<ul style="list-style-type: none"> Benang dan rambut tersangkut di roda penggerak. <p>→ Bersihkan dari roda penggerak (Gambar M-2). <ul style="list-style-type: none"> Robot Pembersih melewati area berpembatas dengan permukaan bagian atasnya terdorong. <p>→ Hal ini bukan kegagalan fungsi.</p> </p>
Lampu  dan  menyala	<ul style="list-style-type: none"> Terjadi kesalahan pada sensor. <p>→ Matikan, lalu hidupkan Robot Pembersih.</p>
Lampu  dan  menyala	<ul style="list-style-type: none"> Terjadi kesalahan pada Robot Pembersih. <p>→ Matikan, lalu hidupkan Robot Pembersih.</p>
Lampu  berkedip sekali untuk setiap urutan	<ul style="list-style-type: none"> Benang dan rambut tersangkut di sikat sisi dan sikat utama. <p>→ Bersihkan dari sikat (Gambar A, N-3).</p>
Lampu  menyala	<ul style="list-style-type: none"> Kotak debu penuh debu dan kotoran atau filter tersumbat. <p>→ Bersihkan kotak debu (Gambar K-2) dan filter (Gambar K-5).</p>

MEMECAHKAN MASALAH

CATATAN: Jika masalah berlanjut setelah melakukan tindakan perbaikan, hubungi Pusat Servis Makita terdekat.

Gejala	Penyebab/Solusi
Lampu tidak menyala saat tombol  ditekan. Robot Pembersih tidak beroperasi saat tombol pada Robot Pembersih atau remote control ditekan.	<ul style="list-style-type: none"> → Pasang kartrid baterai dengan benar. → Isi penuh daya kartrid baterai. → Tekan tombol  untuk menghidupkan Robot Pembersih.
Robot Pembersih tidak beroperasi.	<ul style="list-style-type: none"> → Jika lampu Pemecahan masalah , Pemeliharaan filter , atau Pemeliharaan sikat  menyala atau berkedip, lihat "MENYIMPAN ROBOT PEMBERSIH" untuk mengatasi masalah. → Jika lampu pilot berkedip pelan, tekan terus tombol DAYA  pada Robot Pembersih hingga semua indikator mati, atau tekan tombol DAYA MATI  pada remote control untuk menghapus timer.
Robot Pembersih memulai operasi secara otomatis.	<ul style="list-style-type: none"> • Timer hidup otomatis telah diaktifkan.
Robot Pembersih berhenti beroperasi selama pembersihan.	<ul style="list-style-type: none"> → Matikan Robot Pembersih, lalu bersihkan kawat, tali, dll. dari roda penggerak. → Jika Robot Pembersih terhalang pembatas atau benda lainnya, pindahkan Robot Pembersih ke lokasi lain.
Kecepatan jelajah tidak konstan.	<ul style="list-style-type: none"> • Jika penghalang terdeteksi, Robot Pembersih akan melambat karena memerlukan waktu untuk menghitung arah jalan. Ini bukan kegagalan fungsi Robot Pembersih.
Robot Pembersih tidak berjalan lurus.	<ul style="list-style-type: none"> → Matikan Robot Pembersih, bersihkan semua benda asing yang tersangkut di roda penggerak. → Bersihkan sensor ultrasonik.
Robot Pembersih lebih sering menabrak penghalang dibanding sebelumnya.	<ul style="list-style-type: none"> → Bersihkan sensor ultrasonik.
Robot Pembersih jatuh dari tangga atau ke lantai yang lebih rendah.	<ul style="list-style-type: none"> → Bersihkan sensor jurang. • Robot Pembersih mungkin tidak dapat menghindari undakan dengan tinggi 5,5 cm atau kurang. Ini bukan kegagalan fungsi Robot Pembersih.
Suara pengoperasian lebih kencang dari biasanya.	<ul style="list-style-type: none"> → Kosongkan kotak debu dan bersihkan filter, sikat sisi, serta sikat utama.
Daya isap tidak cukup kuat untuk mengisap debu dan kotoran.	<ul style="list-style-type: none"> → Kosongkan kotak debu dan bersihkan filter. → Tekan tombol Vakum  pada Robot Pembersih atau pada remote control untuk menghidupkan kipas vakum.

Sikat sisi terlepas.	→ Pasang sikat sisi dengan benar (Gambar A).
Sikat sisi tidak berputar atau sulit berputar.	→ Bersihkan sikat sisi dan sikat utama. → Pasang sikat utama dan pelat dengan benar (Gambar N).
Udara pemuangan berbau.	→ Kosongkan kotak debu dan bersihkan filter.
Remote control tidak berfungsi.	<ul style="list-style-type: none"> → Pasang baterai remote control dengan benar (Gambar E). → Ganti baterai dengan yang baru. → Tekan tombol DAYA  pada Robot Pembersih untuk menghidupkannya. → Geser lebih dekat dengan Robot Pembersih atau singkirkan penghalang antara Robot Pembersih dan remote control. → Hentikan penggunaan Robot Pembersih di dekat atau jauhkan dari peralatan yang menggunakan frekuensi radio pada gelombang 2,4 GHz (microwave dapur, perangkat Bluetooth, perangkat Wi-Fi, dsb.). → Matikan, lalu hidupkan Robot Pembersih.
Timer hidup otomatis tidak berfungsi.	<ul style="list-style-type: none"> → Gunakan kartrid baterai yang terisi penuh. → Aktifkan ulang timer hidup otomatis.

AKSESORI OPSIONAL

 **PERHATIAN:** Aksesori atau perangkat tambahan tersebut disarankan untuk digunakan dengan alat Makita yang dijelaskan dalam panduan ini. Penggunaan aksesori atau perangkat tambahan lainnya dapat menimbulkan risiko cedera. Gunakan hanya aksesori atau perangkat tambahan untuk tujuan yang telah dijelaskan.

- Pita pembatas
- Sikat sisi
- Sikat utama
- Pelat bawah
- Filter
- Baterai dan pengisi daya asli Makita

CATATAN: Beberapa item dalam daftar mungkin tersedia dalam kemasan alat sebagai aksesori standar. Item tersebut dapat berbeda di setiap negara.

INFORMASI REFERENSI

Makita Corporation dan anak perusahaan, afiliasi, dan distributornya dapat menggunakan Informasi Penggunaan untuk keperluan layanan purnajual seperti pemeliharaan dan perbaikan. Informasi Penggunaan berisi jumlah operasi, beban distribusi, informasi kesalahan, status pengoperasian, dan/atau catatan pemeliharaan perkakas listrik.

TIẾNG VIỆT (Những hướng dẫn ban đầu)

CẢNH BÁO: Máy này không dành cho những người (bao gồm cả trẻ em) suy giảm thể chất, giác quan hoặc khả năng trí óc, hoặc thiếu kinh nghiệm và kiến thức sử dụng. Trẻ em cần được giám sát để đảm bảo rằng chúng sẽ không nghịch thiết bị.

CÁC ĐẶC ĐIỂM KỸ THUẬT

Hộp pin tiêu chuẩn	BL1815N, BL1820B, BL1830B, BL1840B, BL1850B, BL1860B
Tuổi thọ pin (khi sử dụng pin lithium ion tùy chọn)	Khoảng 120 phút sử dụng hai pin BL1830 (18 V, 3 Ah mỗi pin) Khoảng 200 phút sử dụng hai pin BL1850 (18 V, 5 Ah mỗi pin)
Dung tích hộp	2,5 L
Kích thước (rộng/dài/cao) (bao gồm các pin BL1830)	Khoảng 460 x 460 x 180 mm
Trọng lượng (bao gồm hai pin BL1830)	Khoảng 7,8 kg

- Do chương trình nghiên cứu và phát triển liên tục của chúng tôi nên các đặc điểm kỹ thuật trong đây có thể được thay đổi mà không cần thông báo trước.
- Các đặc điểm kỹ thuật có thể khác nhau tùy theo từng quốc gia.

Các biểu tượng



Đọc hướng dẫn sử dụng.



Không bước lên hoặc đặt các vật lên Máy Hút Bụi Tự Động.



Không sử dụng Máy Hút Bụi Tự Động gần ngọn lửa trực tiếp hoặc các vật liệu dễ cháy và/hoặc nguy hiểm.



Lau chùi các cảm biến đứng ở mặt dưới nếu chúng bị bẩn hoặc ẩm ướt.

Mục đích sử dụng

Đây là Máy Hút Bụi Tự Động dùng để làm sạch sàn trong nhà. Bộ điều khiển từ xa kết nối không dây (2,4 GHz ZigBee) với Máy Hút Bụi Tự Động.

CÁC BIỆN PHÁP PHÒNG NGỪA AN TOÀN

CẢNH BÁO

Không sử dụng Máy Hút Bụi Tự Động gần hoặc hút các chất dễ cháy.

Điều này có thể gây nổ hoặc cháy.

- Dầu lửa, xăng, nhang, nến
- Ét xăng, dung môi
- Tàn thuốc lá
- Mực tone hoặc các chất dễ bắt lửa khác
- Chất tẩy thảm hoặc các chất tạo bọt khác

Không sử dụng Máy Hút Bụi Tự Động ở những nơi ẩm ướt, những nơi có thể bị ẩm ướt, hoặc những nơi có nhiệt độ và độ ẩm cao. Đồng thời, cũng không thực hiện hút nước.

Điều này có thể gây điện giật, đoản mạch, cháy, biến dạng hoặc hỏng hóc.

- Nhà bếp và những nơi khác có sử dụng nước
- Nhà tắm
- Buồng tắm vòi sen
- Áp mái, v.v...

Không chạm vào Máy Hút Bụi Tự Động bằng tay ướt.

Điều này có thể gây điện giật.

Không sử dụng Máy Hút Bụi Tự Động quanh bếp lò hoặc thiết bị nhiệt khác.

Điều này có thể gây điện giật, đoản mạch, cháy, biến dạng hoặc hỏng hóc.

Không sử dụng Máy Hút Bụi Tự Động ở các loại địa điểm sau đây.

Điều này có thể gây điện giật hoặc thương tích.

- Gần trẻ sơ sinh hoặc những người suy giảm thể chất, giác quan hoặc khả năng trí óc, hoặc thiếu kinh nghiệm và kiến thức sử dụng
- Gần động vật
- Gần khu vực đông người hoặc mua bán tấp nập

Không cho phép trẻ em ngoài tầm giám sát hoặc những người không thể hiện được sự sẵn sàng hoặc không có khả năng tự vận hành Máy Hút Bụi Tự Động để sử dụng Máy Hút Bụi Tự Động.

Điều này có thể gây điện giật hoặc thương tích.

Dừng tiếp tục vận hành ngay lập tức trong trường hợp có bất thường hoặc hỏng hóc như sau.

Việc không tuân theo hướng dẫn này có thể gây ra khói, cháy hoặc điện giật.

- Máy Hút Bụi Tự Động không hoạt động ngay cả khi nó đã được BẬT.
- Máy Hút Bụi Tự Động bị biến dạng hoặc nóng bất thường.

- Máy Hút Bụi Tự Động thỉnh thoảng dừng lại trong khi vận hành.
- Máy Hút Bụi Tự Động tạo ra tiếng ồn bất thường trong khi vận hành.
- Máy Hút Bụi Tự Động phát ra mùi khét.

TẮT Máy Hút Bụi Tự Động ở những địa điểm bị cấm sử dụng.

Việc không tuân theo hướng dẫn này có thể làm cho thiết bị y tế hoạt động không chính xác.
Đảm bảo tuân theo các hướng dẫn của từng cơ quan y tế khi sử dụng thiết bị phát ra sóng vô tuyến bên trong các cơ quan y tế.

Không sử dụng Máy hút bụi Tự động ở các vị trí hẹp và trên cao mà không che chắn.

Điều này có thể làm cho Máy Hút Bụi Tự Động rơi khỏi khu vực, gây ra thương tích hoặc hỏng hóc.

- Cầu thang
- Đầu bàn, kệ, tủ quần áo, tủ lạnh, v.v...
- Gác lửng, gác xếp, chiếu nghỉ cầu thang hoặc lối đi vào, v.v...
- Các địa điểm có dốc nghiêng từ 10° trở lên

Không để Máy Hút Bụi Tự Động tiếp xúc với ánh nắng mặt trời trực tiếp hoặc các tia hồng ngoại.

Hoạt động không chính xác do lỗi cảm biến có thể làm cho Máy Hút Bụi Tự Động rơi ngã, gây ra thương tích hoặc hỏng hóc.

- Bộ cấp nhiệt halogen
- Điều khiển từ xa hoặc cảm biến, v.v...
- Các tia nắng xuyên qua kính mờ

Hãy di chuyển bất kỳ vật nào có thể gây ra tai nạn trong trường hợp tiếp xúc với Máy Hút Bụi Tự Động.

Việc không tuân theo hướng dẫn này có thể gây ra thương tích do vật bị lật nghiêng hoặc rơi ngã.

- Nền đã thấp, lồi hõa, v.v...
- Thiết bị điện tử có điều khiển được đặt cùng chiều cao với Máy Hút Bụi Tự Động.

Không che chắn Máy Hút Bụi Tự Động.

Điều này có thể gây ra cháy do quá nhiệt.

Không cưỡi hoặc đặt các vật nặng lên Máy Hút Bụi Tự Động. Không tác dụng lực sốc vật lý mạnh.

Điều này có thể gây ra thương tích, hư hỏng hoặc hỏng hóc.

Đặc biệt, hãy chú ý cẩn thận khi trẻ em ở quanh Máy Hút Bụi Tự Động.

Không được cải tạo Máy Hút Bụi Tự Động.

Điều này có thể gây cháy, điện giật hoặc thương tích.
Liên hệ với đại lý bạn đã mua Máy Hút Bụi Tự Động để sửa chữa.

Không được chặn hoặc chèn ngoại vật kim loại hoặc dễ cháy vào các lỗ hút hoặc xả. Đồng thời, không được sử dụng Máy Hút Bụi Tự Động quanh những vật có thể chặn lỗ hút.

Điều này có thể gây điện giật, cháy hoặc hỏng hóc.

Không đốt nóng hoặc để Máy Hút Bụi Tự Động tiếp xúc với lửa hoặc đặt nó ở một nơi nóng như ở gần lửa hoặc bếp lò, tiếp xúc với ánh sáng mặt trời trực tiếp, hoặc đặt bên trong một chiếc xe dưới nắng gắt.

Điều này có thể gây ra đoản mạch, cháy, hoặc làm cho pin rò rỉ chất lỏng hoặc nổ.

Không được rửa hoặc để Máy Hút Bụi Tự Động* tiếp xúc với nước hoặc chất tẩy rửa.

Điều này có thể gây điện giật, đoản mạch hoặc cháy.

- * Không bao gồm bàn chải chính, đĩa đáy, bàn chải cạnh, hộp chứa bụi và bộ lọc

Không chạm vào bánh xe dẫn động hoặc đưa tay hoặc chân vào bên dưới Máy Hút Bụi Tự Động trong khi vận hành.

Điều này có thể gây ra thương tích.

Đặc biệt, hãy chú ý cẩn thận khi trẻ em ở quanh Máy Hút Bụi Tự Động.

Không được chặn hoặc chèn ngoại vật vào cảm biến của Máy Hút Bụi Tự Động.

Điều này có thể gây ra lỗi vận hành, thương tích do Máy Hút Bụi Tự Động rơi ngã vì hoạt động không chính xác hoặc hỏng hóc.

Không được dán băng dính vào cảm biến hoặc bánh xe. Không làm thay đổi Hình dạng bộ giảm xung hoặc bánh xe hoặc nhấn bộ giảm xung với lực quá mạnh.

Điều này có thể gây ra lỗi vận hành, thương tích do Máy Hút Bụi Tự Động rơi ngã vì hoạt động không chính xác hoặc hỏng hóc.

Vệ sinh định kỳ từng cảm biến.

Việc không tuân theo hướng dẫn này có thể gây ra lỗi vận hành, thương tích do Máy Hút Bụi Tự Động rơi ngã vì hoạt động không chính xác hoặc hỏng hóc.

Không sử dụng băng chắn ranh giới (được bán riêng) đã bị bẩn, bong tróc hoặc rách.

Điều này có thể gây ra thương tích do Máy Hút Bụi Tự Động rơi ngã vì hoạt động không chính xác.



Không sử dụng Máy Hút Bụi Tự Động ở các địa điểm sau đây.

Điều này có thể khiến cho các thiết bị khác hoạt động không chính xác.

- Bên trong một bệnh viện hoặc xung quanh thiết bị y tế
- Bên trong máy bay
- Xung quanh thiết bị điện tử đòi hỏi phải kiểm soát chính xác hoặc sử dụng tín hiệu yếu.

Hãy đảm bảo giữ Máy Hút Bụi Tự Động và điều khiển từ xa cách máy điều hòa nhiệt độ và máy khử rung tim cấy dưới da trên 15 cm.

Việc không tuân theo hướng dẫn này có thể gây ra hỏng hóc thiết bị y tế.

Không được chèn ngoại vật vào các khe hở và lỗ.

Điều này có thể gây điện giật hoặc thương tích.

Cẩn thận không để các ngón tay của bạn bị kẹt vào khi vệ sinh Máy Hút Bụi Tự Động.

Điều này có thể gây ra thương tích.

Đảm bảo đọc kỹ HƯỚNG DẪN SỬ DỤNG trước khi sử dụng Máy Hút Bụi Tự Động.

Việc không tuân theo hướng dẫn này có thể gây ra thương tích hoặc hỏng hóc.

THÔNG BÁO

Dừng tiếp tục sử dụng hộp pin ngay lập tức nếu nhận thấy có mùi khó chịu, rò rỉ pin, nóng bất thường, biến dạng, hoặc đổi màu.

Việc không tuân theo hướng dẫn này có thể gây ra hỏng hóc.

Không sử dụng Máy Hút Bụi Tự Động ở ngoài trời hoặc ở những nơi mà máy có thể dịch chuyển ra ngoài trời.

Điều này có thể gây ra hỏng hóc.

Không sử dụng Máy Hút Bụi Tự Động ở các địa điểm sau đây.

Điều này có thể gây ra hỏng hóc.

- Những địa điểm mà các phần tử dầu ăn hoặc các thành phần dầu khác đang lơ lửng trong không khí
- Những địa điểm mà bình xịt aerosol hoặc các sản phẩm hóa chất được sử dụng, chẳng hạn như các cửa hàng cắt tóc, thẩm mỹ viện, và các cửa hàng giặt khô
- Những địa điểm đầy bụi

Không sử dụng Máy Hút Bụi Tự Động ở các địa điểm sau đây.

Điều này có thể làm hỏng lớp trải sàn hoặc làm trầy bề mặt sàn.

- Những địa điểm có lớp trải sàn dễ bị hư hỏng (da cừu, vải dạ, v.v...)
- Sàn bằng gỗ bán thành phẩm hoặc đá cẩm thạch
- Sàn mới được bồi sấp

Không sử dụng Máy Hút Bụi Tự Động trên lớp trải sàn có chiều dài cọc dài (từ 7 mm trở lên).

Điều này có thể gây hư hỏng cho lớp trải sàn hoặc làm cho Máy Hút Bụi Tự Động bị hỏng hóc.

Không sử dụng Máy Hút Bụi Tự Động trên mặt sàn cứng, không bằng phẳng như sàn bê tông, v.v...

Điều này có thể làm bàn chải và bánh xe mau mòn nhanh.

Không sử dụng Máy Hút Bụi Tự Động nếu bàn chải và bánh xe bị mòn.

Điều này có thể gây trầy xước bề mặt sàn.

Dừng tiếp tục việc vận hành và liên hệ với đại lý nơi bạn đã mua Máy Hút Bụi Tự Động.

Loại bỏ bất kỳ bụi bẩn đất cát bám vào bàn chải chính, bàn chải cạnh và bánh xe.

Việc không tuân theo hướng dẫn này có thể làm cho bề mặt sàn bị trầy xước.

Không hút các món đồ sau đây.

Điều này có thể làm trầy xước hoặc làm tắc nghẽn bên trong Máy Hút Bụi Tự Động hoặc gây hỏng hóc.

- Chất lỏng hoặc rác ướt
- Hóa chất hoặc dầu
- Phân thú cưng
- Một khối lượng lớn cát hoặc bột
- Vật sắc nhọn (thủy tinh, lưỡi dao, đinh ghim, v.v...)
- Giấy lớn hoặc rác nhựa vinyl
- Dây cáp hoặc dây

Vệ sinh bộ lọc sau khi hút bột mịn (thạch cao, xi măng, phấn, v.v...).

Việc không tuân theo hướng dẫn này có thể gây ra hỏng hóc.

Không sử dụng Máy Hút Bụi Tự Động nếu bộ lọc bị tắc hoặc các cảm biến bị bẩn.

Điều này có thể gây ra hỏng hóc.

Không được tra dầu bôi trơn vào trục xoay hoặc các bộ phận chuyển động khác.

Điều này có thể làm nứt nhựa.

GIỮ GÌN CÁC HƯỚNG DẪN NÀY

Sử dụng và bảo quản dụng cụ dùng pin

1. Chỉ sạc pin lại với bộ sạc do nhà sản xuất quy định. Bộ sạc phù hợp với một loại bộ pin này có thể gây ra nguy cơ hỏa hoạn khi được dùng cho một bộ pin khác.
2. Chỉ sử dụng các dụng cụ máy với các bộ pin được quy định cụ thể. Việc sử dụng bất cứ bộ pin nào khác có thể gây ra thương tích và hỏa hoạn.
3. Khi không sử dụng bộ pin, hãy giữ nó tránh xa kẹp giấy, tiền xu, chìa khóa, đinh, ốc vít hoặc các vật nhỏ bằng kim loại khác mà có thể làm nối tất các đầu cực pin.
4. Trong điều kiện sử dụng quá mức, pin có thể bị chảy nước; hãy tránh tiếp xúc. Nếu lỡ tiếp xúc, hãy rửa sạch bằng nước.

Các hướng dẫn an toàn quan trọng cho hộp pin

1. Trước khi sử dụng hộp pin, hãy đọc tất cả các hướng dẫn và dấu hiệu phòng ngừa trên (1) bộ sạc pin, (2) pin, và (3) sản phẩm sử dụng pin.
2. Không được tháo rời hộp pin.
3. Nếu thời gian vận hành trở nên ngắn hơn bình thường một cách đáng kể, hãy dừng vận hành ngay lập tức. Điều này có thể gây ra nguy cơ quá nhiệt, có thể gây cháy và thậm chí có thể gây nổ.
4. Nếu chất điện phân dính vào mắt, hãy rửa mắt với nước sạch và tìm đến chăm sóc y tế ngay. Điều này có thể gây mất thị lực.
5. Không được làm đoản mạch hộp pin:
 - (1) Không chạm vào các đầu cực pin với vật liệu dẫn điện bất kỳ.
 - (2) Tránh cất giữ hộp pin trong một thùng chứa có các vật kim loại khác như đinh, tiền xu, v.v...
 - (3) Không để hộp pin tiếp xúc với nước hoặc mưa.Đoản mạch pin có thể gây ra một dòng điện lớn, quá nhiệt, có thể gây cháy và thậm chí là hỏng vỡ máy.
6. Không cất giữ Máy Hút Bụi Tự Động và hộp pin ở bất kỳ nơi nào có nhiệt độ có thể lên tới hoặc vượt quá 50°C.
7. Không được đốt hộp pin ngay cả khi nó bị hư hỏng nghiêm trọng hoặc đã cạn hoàn toàn. Hộp pin có thể phát nổ khi gặp lửa.
8. Cần thận không được làm rơi hoặc va đập hộp pin.
9. Không được sử dụng hộp pin đã bị hư hỏng.

10. **Tuân thủ các quy định tại địa phương bạn liên quan đến việc thải bỏ các hộp pin.**

GIỮ GÌN CÁC HƯỚNG DẪN NÀY

⚠CHÚ Ý: Chỉ sử dụng pin chính hãng Makita. Sử dụng pin Makita không chính hãng, hoặc pin đã được thay đổi, có thể dẫn đến pin nổ gây cháy, bị thương và thiệt hại. Sẽ làm mất hiệu lực bảo hành Makita đối với dụng cụ và bộ sạc Makita.

Mẹo kéo dài tuổi thọ pin tối đa

1. **Sạc pin hộp pin trước khi nó được xả hoàn toàn. Luôn dùng vận hành và sạc hộp pin khi bạn nhận thấy nguồn điện của dụng cụ còn ít.**
2. **Không bao giờ sạc lại hộp pin đã sạc đầy. Sạc điện quá mức sẽ rút ngắn tuổi thọ pin.**
3. **Sạc hộp pin trong phạm vi nhiệt độ phòng từ 10°C - 40°C. Hãy để một hộp pin nóng nguội xuống trước khi sạc nó.**
4. **Sạc hộp pin trước khi cất giữ máy trong thời gian dài (hơn sáu tháng).**

Hệ thống bảo vệ dụng cụ/hộp pin

Máy Hút Bụi Tự Động được trang bị một hệ thống bảo vệ dụng cụ/hộp pin giúp tự động TẮT nguồn điện dẫn đến động cơ để kéo dài tuổi thọ của Máy Hút Bụi Tự Động và các hộp pin. Máy Hút Bụi Tự Động tự động dừng dưới những điều kiện sau.

Quá tải

Khi Máy Hút Bụi Tự Động bị quá tải và dòng điện cao bất thường được phóng ra, Máy Hút Bụi Tự Động sẽ tự động dừng lại mà không cần bất kỳ chi thị nào. Để khởi động lại Máy Hút Bụi Tự Động, hãy TẮT nguồn, loại bỏ các nguyên nhân gây ra tình trạng quá tải, và sau đó BẬT nguồn trở lại.

Quá nhiệt

Khi Máy Hút Bụi Tự Động bị quá nhiệt, đèn  sẽ nhấp nháy 5 hoặc 7 lần liên tục và tự động dừng Máy Hút Bụi Tự Động.

Trong trường hợp này, hãy để Máy Hút Bụi Tự Động nguội trước khi BẬT nguồn trở lại.

Xả quá mức





Khi mức pin còn lại thấp, Máy Hút Bụi Tự Động sẽ tự động dừng và không hồi đáp bất kỳ hoạt động chuyển đổi nào.









Trong trường hợp này, hãy tháo và sạc lại hộp pin.

CÁC NÚT VÀ ĐÈN CHỈ BÁO









Bạn có thể tìm thấy chi tiết của các bộ phận bằng cách tìm số thứ tự hình tương ứng với từng bộ phận trong tài liệu này (ví dụ: tìm "Hình F-8" cho nút  NGUỒN).

Máy Hút Bụi Tự Động (Hình F)

1. Đèn báo
2.  Đèn xử lý sự cố
3.  Đèn báo đường bộ lọc
4.  Đèn báo đường bàn chải
5.  Đèn chỉ báo pin (đối với các hộp pin bên phải và bên trái)

6.  Nút hẹn giờ và đèn
7.  Nút chế độ hành trình và đèn
 : Chế độ kiểu mẫu
 : Chế độ ngẫu nhiên
8.  Nút NGUỒN (khởi động/dừng)
9.  Nút còi và đèn
10.  Nút hút và đèn
11.  Nút và đèn cảm biến ranh giới

Điều khiển từ xa (Hình G)

1.  Nút TẮT NGUỒN
2.  Nút khởi động/dừng
3.  Nút đèn hiệu vị trí
4.  /  Nút chế độ hành trình
5.  Nút hẹn giờ
6.  Nút còi
7.  Nút hút

TRƯỚC KHI SỬ DỤNG

Lắp ráp và lắp pin

⚠CHÚ Ý: Luôn đảm bảo TẮT Máy Hút Bụi Tự Động trước khi thực hiện bất kỳ công việc nào trên Máy Hút Bụi Tự Động.

Phụ kiện được cung cấp

Kiểm tra xem các món đồ trong danh sách sau đây có bao gồm trong gói hay không.

- Pin cỡ AAA (LR03) (x2)
- Bàn chải cạnh (x4, bao gồm hai bàn chải dự phòng)
- Ốc vít để lắp bàn chải cạnh (x4)
- Băng chắn ranh giới (15 m x1)
- Sách hướng dẫn sử dụng (x1)
- Hướng dẫn khởi động nhanh (x1)
- Lưu ý khi sử dụng (x1)

Lắp bàn chải cạnh (Hình A)

Lắp bàn chải cạnh ở cả hai mặt của mặt trước và mặt đáy của Máy Hút Bụi Tự Động.

THÔNG BÁO: Trước khi làm việc, hãy đảm bảo trải tấm thảm hoặc vật liệu đệm khác trên sàn nhà để tránh hư hỏng sàn nhà và Máy Hút Bụi Tự Động (Hình B).

1. Đặt bàn chải cạnh lên đầu trục xoay trên Máy Hút Bụi Tự Động có các rãnh của bàn chải khớp với đầu trục.
2. Cố định bàn chải cạnh bằng cách sử dụng ốc vít được cung cấp.

THÔNG BÁO: Đảm bảo rằng Máy Hút Bụi Tự Động này được vận hành với bàn chải cạnh đã được lắp đặt.

Lắp các hộp pin

Căn chỉnh rãnh (Hình C-2) trên hộp pin với chốt (Hình C-3) trên hộp dụng cụ và trượt nó vào vị trí. Đẩy hộp pin bằng mọi cách cho đến khi nó khóa chặt vào vị trí với một tiếng cách nhỏ.

Nếu bạn có thể thấy đèn chỉ báo màu đỏ (Hình C-1) ở phía trên của nút nhà, hộp pin vẫn chưa được khóa hoàn toàn.

⚠CHÚ Ý: Cần phải cẩn thận trong việc lắp đặt hộp pin để ngón tay không bị kẹt giữa lỗ sạc và hộp pin.

Máy Hút Bụi Tự Động hoạt động với chỉ một hộp pin được lắp trên một trong hai hộp đựng pin.

Đề tháo hộp pin, trượt hộp pin từ hộp đựng pin trong khi nhấn nút nhà (Hình D-1) trên hộp.

Lắp pin vào điều khiển từ xa (Hình E)

Trượt nắp ngăn chứa pin và gắn hai pin cỡ AAA (LR03), chú ý cẩn thận để căn chỉnh các cực (+/-) chính xác.





THÔNG BÁO: Không sử dụng pin mới và cũ chung với nhau, cũng không sử dụng các loại pin khác nhau chung với nhau.

THÔNG BÁO: Tháo pin ra, nếu không sử dụng điều khiển từ xa trong một thời gian dài.

⚠CHÚ Ý: Nếu da hoặc mắt tiếp xúc với chất điện phân rò rỉ từ pin, hãy lập tức rửa sạch bằng nước.

Ghép nối Máy Hút Bụi Tự Động và điều khiển từ xa

Máy Hút Bụi Tự Động đã được ghép nối với điều khiển từ xa. Tuy nhiên, phải thực hiện một lần nữa quá trình ghép nối nếu bạn thay điều khiển từ xa.

1. Nhấn và giữ các nút  Hẹn giờ (Hình F-6) và  Chế độ hành trình (Hình F-7) cùng lúc trên Máy Hút Bụi Tự Động cho đến khi nghe còi kêu bip hai lần.
2. Nhấn và giữ các nút  Hẹn giờ (Hình G-5) và  Đèn hiệu vị trí (Hình G-3) cùng lúc điều khiển từ xa cho đến khi nghe còi kêu bip hai lần.

Nếu ghép nối không thành công và còi kêu bip 5 lần, vui lòng thử ghép nối lại lần nữa.

Tổ chức bố trí các phòng

Đề đảm bảo hành trình suôn sẻ

- Đóng các cánh cửa dẫn vào phòng. Nếu sự khác biệt về mức độ của ngưỡng cửa nhỏ đủ để Máy Hút Bụi Tự Động có thể vượt qua mà không có vấn đề, có thể để cửa mở để Máy Hút Bụi Tự Động tiếp tục và dọn dẹp các phòng liền kề.
- Đặt chương ngại vật trước những đồ nội thất dễ bị hư hỏng, v.v...
- Đặt chương ngại vật để ngăn Máy Hút Bụi Tự Động vào nơi mà máy có thể bị kẹt, chẳng hạn như dưới những giá kệ thấp.
- Di chuyển những vật thể cao, mảnh và không ổn định và những vật thể dễ bị lật nghiêng sang một phòng khác.
- Khóa bánh xe của xe đẩy hoặc các vật thể khác, hoặc di chuyển chúng sang một phòng khác.
- Sắp xếp các dây điện dọc theo các bức tường.
- Di chuyển đệm, sách hoặc các vật thể khác có thể ngăn Máy Hút Bụi Tự Động thực hiện hành trình sang một phòng khác.
- Nâng các bộ phận của rèm cửa hoặc các vật khác rủ xuống sàn nhà.
- Di chuyển lớp trải sàn bất kỳ có sợi dễ bị kéo đi hoặc có sự khác biệt về mức độ và những lớp trải sàn quá mỏng và dễ trượt sang một phòng khác.
- Gấp phần tua rua bất kỳ của lớp trải sàn xuống bên dưới lớp trải sàn.

- Cát bất kỳ vật thể nhỏ hay đất tiền nào mà có thể dễ dàng bị hút lên.
- Cát bất kỳ dây cáp, thắt lưng, dây, giầy mỏng, hoặc túi nhựa nào nằm trên sàn nhà.
- Thu lại bất kỳ ổ cắm điện trên sàn nào có thể thu vào.
- Phủ bất kỳ phần lưới nào đang chia các phần sàn ra bằng những tấm bảng, v.v... vì Máy Hút Bụi Tự Động có thể phát hiện đó là ranh giới và không di chuyển qua chúng.

Ngăn Máy Hút Bụi Tự Động rơi

- Nếu khu vực làm sạch có đợt cầu thang hoặc phần khác mà Máy Hút Bụi Tự Động có thể rơi xuống, thì để Máy Hút Bụi Tự Động nằm ngoài phần này, phải đặt vật thể có chiều cao từ 15 cm trở lên và đủ nặng để chịu được tác động của Máy Hút Bụi Tự Động ở phía trước phần này.
- Ngăn ánh sáng mặt trời và các tia hồng ngoại bằng rèm cửa. (Máy Hút Bụi Tự Động có thể giảm xuống một mức thấp hơn khi lùi lại tránh ánh sáng mặt trời hoặc tia hồng ngoại.)
- Đóng cửa có khung nhôm. (Máy Hút Bụi Tự Động có thể không phát hiện sự khác biệt về mức độ giữa thanh ngang khung cửa nhôm và sàn và có thể rơi ra khỏi cửa.)
- Di chuyển bất kỳ lớp phủ sàn gần như khác biệt về mức độ sang một phòng khác. (Máy Hút Bụi Tự Động có thể không phát hiện được sự khác biệt và có thể ngã.)

LƯU Ý

- Không sử dụng Máy Hút Bụi Tự Động gần hoặc hút chất dễ cháy. (Điều này có thể gây nổ hoặc cháy.)
- Không sử dụng Máy Hút Bụi Tự Động ở những nơi ẩm ướt, những nơi có thể bị ẩm ướt, hoặc những nơi có nhiệt độ và độ ẩm cao. Đồng thời, cũng không thực hiện hút nước. (Điều này có thể gây điện giật, đoản mạch, cháy, biến dạng hoặc hỏng hóc.)
- Không sử dụng Máy Hút Bụi Tự Động tại các địa điểm mà khoảng cách tính từ tường đến chỗ khác biệt về mức độ khoảng từ 1 m trở xuống. (Vị chẳng may có khi Máy Hút Bụi Tự Động có thể rơi trong khi lùi lại.)
- Không sử dụng Máy Hút Bụi Tự Động trong các khu vực có vật chắn mà Máy Hút Bụi Tự Động không thể leo lên được đặt xung quanh tường hoặc các chương ngại vật. Máy Hút Bụi Tự Động có thể bị kẹt vào vật chắn trong khi di chuyển ngược lại để tránh những bức tường hoặc các chương ngại vật.
- Ngắt kích hoạt tất cả các hệ thống an ninh tại trong nhà, v.v... (Máy Hút Bụi Tự Động có thể bị phát hiện nhầm là một kẻ xâm nhập.)
- Máy Hút Bụi Tự Động không thể tránh được những chỗ khác biệt về mức độ từ 5,5 cm trở xuống.
- Nhiều sóng có thể xuất hiện trên màn hình TV trong khi đang vận hành. (Đây không phải do tivi hỏng hóc.)
- Không để Máy Hút Bụi Tự Động trong thời gian dài với hộp pin đã lắp. (Chất điện phân của pin có thể bị rò rỉ.)
- Không được để Máy Hút Bụi Tự Động lộn ngược với các hộp pin được lắp. (Nút có thể bị nhấn, dẫn đến vận hành không lường trước được.)

QUÁ TRÌNH VẬN HÀNH

Máy Hút Bụi Tự Động chạy xung quanh sàn theo chế độ hành trình định sẵn, tránh chướng ngại vật bằng cách sử dụng cảm biến siêu âm (Hình P-1), và bắt bụi, bắn và các mảnh vỡ trên đường đi bằng cách sử dụng bàn chải cạnh, bàn chải chính, và quạt hút. Tuy nhiên, các cảm biến có thể không phát hiện ra chướng ngại vật trong một số tình huống. Nếu Máy Hút Bụi Tự Động của bạn va phải một chướng ngại vật, thì đèn của Máy Hút Bụi Tự Động (Hình P-2) sẽ nhấp nháy tác động và thay đổi hướng đi.





- LƯU Ý:** Có thể có trường hợp Máy Hút Bụi Tự Động không thể đi qua những rào chắn ở độ cao lên đến 1,5 cm, mặc dù Máy Hút Bụi Tự Động được thiết kế để vượt qua rào chắn này.
- LƯU Ý:** Máy Hút Bụi Tự Động có thể tránh khu vực mà có màu đen, sàn kiểu vân gỗ màu đen, hoặc khu vực làm bằng thủy tinh.
- LƯU Ý:** Sau một chu kỳ làm sạch được hoàn thành, một số bụi và chất bẩn có thể vẫn còn trong điều kiện nhất định.
- LƯU Ý:** Giao tiếp không dây có thể bị gián đoạn hoặc bị nghẽn theo các điều kiện sau đây:
- Cấu trúc bên trong được xây dựng bằng bê tông cốt thép hoặc vật liệu xây dựng bằng kim loại
 - Khi Máy Hút Bụi Tự Động ở phía sau vật cản
 - Thiết bị thông tin vô tuyến gần đó sử dụng cùng băng tần số
 - Các thiết bị gần đó phát ra điện từ trường (lò vi sóng, v.v...) hoặc tĩnh điện, hoặc do nhiễu sóng vô tuyến gây ra



Quá trình vận hành cơ bản

⚠️CHÚ Ý: Luôn đảm bảo rằng Máy Hút Bụi Tự Động đã được TẮT trước khi điều chỉnh hoặc kiểm tra bất kỳ chức năng trên Máy Hút Bụi Tự Động.

THÔNG BÁO: Nếu xảy ra ngưng tụ sương, TẮT Máy Hút Bụi Tự Động và chờ đợi cho đến khi Máy Hút Bụi Tự Động khô, trước khi vận hành khởi động lại.



THÔNG BÁO: Tất cả các thiết lập không được xóa khi Máy Hút Bụi Tự Động được TẮT. Hãy đảm bảo xác nhận rằng các thiết lập là đúng bằng các bóng đèn (Hình F-6, 7, 9, 11) trên Máy Hút Bụi Tự Động để ngăn chặn vận hành không mong muốn.

1. Nhấn nút  NGUỒN (Hình F-8) trên Máy Hút Bụi Tự Động.
 Máy Hút Bụi Tự Động vào chế độ dự phòng và đèn chỉ báo pin  (Hình F-5) sáng lên. (Để biết thêm chi tiết, vui lòng xem “Đèn chỉ báo pin trên Máy Hút Bụi Tự Động” bên dưới.)
2. Nhấn nút Chế độ hành trình  (Hình F-7) trên Máy Hút Bụi Tự Động lặp đi lặp lại nhiều lần để chọn chế độ, hoặc nhấn nút  hoặc nút Chế độ hành trình  (Hình G-4) trên điều khiển từ xa.
 Đèn ở chế độ lựa chọn sáng lên. (Để biết thêm chi tiết, vui lòng xem “Chế độ hành trình” dưới đây.)

3. Nhấn nút  NGUỒN (Hình F-8) trên Máy Hút Bụi Tự Động hoặc nút Khởi động/Dừng  (Hình G-2) trên điều khiển từ xa để bắt đầu làm sạch.
 Đèn báo (Hình F-1) nhấp nháy và còi kêu bíp khi làm sạch.

Để tạm dừng các hoạt động làm sạch, thực hiện lại bước 3.

Để tiếp tục các hoạt động làm sạch, thực hiện lại bước 3.





Để TẮT Máy Hút Bụi Tự Động, nhấn và giữ nút  NGUỒN (Hình F-8) trên Máy Hút Bụi Tự Động cho đến khi tất cả các đèn chỉ báo TẮT, hoặc nhấn nút  TẮT NGUỒN (Hình G-1) trên điều khiển từ xa.

⚠️CHÚ Ý: Không nhìn sát gần vào ánh sáng đèn báo, hoặc tránh ánh sáng xa với mắt của bạn. Làm như vậy có thể gây hại cho mắt của bạn.

Đèn chỉ báo pin trên Máy Hút Bụi Tự Động

Đèn chỉ báo pin nằm bên hộp pin tương ứng sáng lên và chỉ báo nguồn điện còn lại của hộp pin.

THÔNG BÁO: Bảng dưới đây cung cấp chỉ báo của lượng pin còn lại. Lượng pin còn lại có thể khác nhau tùy thuộc vào điều kiện sử dụng và nhiệt độ phòng.







	Từ 50% trở lên
	Từ 20% đến 50%
	Từ 20% trở xuống
	Hết pin/Không có hộp pin nào được lắp
	Lỗi pin

Đèn chỉ báo pin trên hộp pin



Có thể kiểm tra nguồn điện còn lại cũng bằng cách sử dụng đèn chỉ báo pin (Hình I-1) trên hộp pin với số kiểu kết thúc bằng chữ “B”.

Tháo hộp pin và nhấn nút  (Hình I-2).

THÔNG BÁO: Bảng dưới đây cung cấp chỉ báo của lượng pin còn lại. Lượng pin còn lại có thể khác nhau tùy thuộc vào điều kiện sử dụng và nhiệt độ phòng.

	Từ 75% trở lên
	Từ 50% đến 75% (bao gồm cả 50%)
	Từ 25% đến 50%
	Từ 25% trở xuống
	Hết pin
	Lỗi pin

Chế độ hành trình

 Chế độ kiểu mẫu	Ứng dụng: Sàn lớn có ít chướng ngại vật chẳng hạn như một nhà kho được sắp xếp gọn và hành lang dài. Mô tả (Hình H-1): Máy Hút Bụi Tự Động lập đi lập lại hành trình theo chiều dọc (a) và chiều ngang (b).*
 Chế độ ngẫu nhiên	Ứng dụng: Sàn với nhiều chướng ngại vật như ở văn phòng. Mô tả (Hình H-2): Máy Hút Bụi Tự Động lập đi lập lại một chu kỳ này lên (c) và các hành trình dọc theo tường (d).

* Tùy thuộc vào điều kiện gặp phải, đường đi thực tế của Máy Hút Bụi Tự Động có thể khác nhau so với biểu đồ này.

LƯU Ý: Máy Hút Bụi Tự Động không thể làm sạch khu vực hẹp nơi Máy Hút Bụi Tự Động không thể di chuyển hoặc nơi nằm ngoài phạm vi tầm với của bàn chải cạnh.

LƯU Ý: Sau khi chu trình làm sạch kết thúc, một số bụi có thể vẫn còn trên sàn nhà trong một số điều kiện.

Chế độ nghỉ

Nếu Máy Hút Bụi Tự Động được để ở chế độ chờ 5 phút, thì Máy Hút Bụi Tự Động sẽ tự động vào chế độ nghỉ để tiết kiệm pin, và đèn báo (Hình F-1) nhấp nháy chậm. Máy Hút Bụi Tự Động cũng đi vào chế độ nghỉ khi bộ hẹn giờ tự bật đã được kích hoạt.

Để trở về chế độ chờ, thực hiện bước 3 trong “Quá trình vận hành cơ bản.”

THÔNG BÁO: Các thay đổi về các cài đặt và khởi động vận hành làm sạch không khả thi trong chế độ này.

Mang Máy Hút Bụi Tự Động

 **CHÚ Ý:** Trước khi vận chuyển Máy Hút Bụi Tự Động, hãy đảm bảo TẮT Máy Hút Bụi Tự Động.

 **CHÚ Ý:** Cần phải cẩn thận để tay của bạn không bị kẹt giữa tay cầm và thân của Máy Hút Bụi Tự Động.



Nắm chặt tay cầm (Hình J-1).

THÔNG BÁO: Nếu bạn đỡ phía sau của Máy Hút Bụi Tự Động bằng tay khác, bạn phải cẩn thận để không nâng phía bên đó quá nhiều làm bụi và chất bẩn trong Máy Hút Bụi Tự Động rơi vào bàn chải chính đang mở.

THÔNG BÁO: Không kéo mạnh Máy Hút Bụi Tự Động.

Dọn sạch thùng

Dọn sạch thùng sau mỗi lần sử dụng để giữ cho Máy Hút Bụi Tự Động vận hành với hiệu suất cao nhất.

- Bấm và giữ nút  NGUỒN (Hình F-8) trên Máy Hút Bụi Tự Động cho đến khi tắt cả các đèn chỉ báo lần lượt TẮT, hoặc bấm nút  TẮT NGUỒN (Hình G-1) trên điều khiển từ xa để TẮT Máy Hút Bụi Tự Động.
- Nhấn và tháo nắp phía trên (Hình K-1) để mở khóa, và sau đó mở nắp hoàn toàn.

- Lấy hộp chứa bụi ra (Hình K-2).
- Khởi phục cả hai ổ khóa (Hình K-3), và mở nắp hộp chứa bụi.
- Lấy hộp chứa bụi ra và dọn sạch thùng phía trên (Hình K-4).
- Dọn những tầng bụi nhỏ khỏi bộ lọc (Hình K-5) và dọn sạch thùng phía dưới (Hình K-6).
- Thay thế hộp chứa bụi trong Máy Hút Bụi Tự Động theo trình tự đảo ngược.

Quá trình vận hành nâng cao

Chỉ có thể thiết lập các tính năng sau đây khi Máy Hút Bụi Tự Động đang ở chế độ chờ (vui lòng xem bước 1 trong “Quá trình vận hành cơ bản”).

Tiết kiệm điện

Máy Hút Bụi Tự Động có thể lấy đi hầu hết bụi để thấy bằng mắt mà không sử dụng quạt hút. Nếu không cần loại bỏ bụi mịn, TẮT quạt hút sẽ tiết kiệm điện để kéo dài thời gian vận hành của Máy Hút Bụi Tự Động.

Trong chế độ chờ, nhấn nút  Hút trên Máy Hút Bụi Tự Động (Hình F-10) hoặc trên điều khiển từ xa (Hình G-7) để TẮT đèn Hút (Hình H-10).

Để BẬT quạt hút, nhấn nút  Hút trên Máy Hút Bụi Tự Động (Hình F-10) hoặc trên điều khiển từ xa (Hình G-7). Đèn sáng lên một lần nữa.

THÔNG BÁO: Thiết lập này là không thể trong chế độ tạm nghỉ với đồng hồ bấm giờ tự động được kích hoạt.

THÔNG BÁO: Trong trường hợp quạt hút được TẮT,  đèn báo dưỡng bộ lọc (Hình F-3) không sáng ngay cả khi bộ lọc đầy bụi bẩn.

Điều chỉnh âm lượng còi

Có thể lựa chọn ba mức âm lượng còi bao gồm chế độ câm.

Trong chế độ chờ, nhấn lập đi lập lại nút  Còi trên Máy Hút Bụi Tự Động (Hình F-9) hoặc trên điều khiển từ xa (Hình G-6). Mỗi lần bạn nhấn nút, còi sẽ kêu bíp theo trình tự sau: ở âm lượng cao (đèn sáng lên), ở âm lượng thấp (đèn sáng lên), và không có âm thanh (đèn sẽ tắt).

THÔNG BÁO: Thiết lập này là không thể trong chế độ tạm nghỉ với đồng hồ bấm giờ tự động được kích hoạt.

Định vị Máy Hút Bụi Tự Động

Tính năng này rất hữu ích cho việc định vị Máy Hút Bụi Tự Động mà có thể khuất tầm nhìn trên một sàn lớn với bàn, tủ, và những thiết bị khác.

Nhấn nút  Đèn hiệu vị trí trên điều khiển từ xa (Hình G-3) trong khi Máy Hút Bụi Tự Động đang ở chế độ chờ hoặc chế độ nghỉ. Còi kêu bíp trong khoảng 10 giây và đèn báo nhấp nháy.

Để ngăn còi và nhấp nháy, nhấn nút  Đèn hiệu vị trí một lần nữa.

LƯU Ý: Có thể có trường hợp khi Máy Hút Bụi Tự Động không phản hồi vì Máy Hút Bụi Tự Động nằm ngoài phạm vi điều khiển từ xa. Vấn đề có thể được giải quyết bằng cách nhấn nút  Đèn hiệu vị trí trong khi bạn đang di chuyển xung quanh sàn nhà.



Sử dụng các bộ hẹn giờ tự bật



Tính năng này cho phép Máy Hút Bụi Tự Động bắt đầu làm sạch tự động sau thời gian quy định. Sau khi xóa thiết lập một khi việc làm sạch hẹn giờ tự động được hoàn thành, thì thực hiện các thủ tục sau đây để kích hoạt lại bộ hẹn giờ tự động.

1. Trong chế độ chờ, nhấn lặp đi lặp lại nút  Hẹn giờ trên Máy Hút Bụi Tự Động (Hình F-6) hoặc trên điều khiển từ xa (Hình G-5). Mỗi lần bạn nhấn nút, thiết lập sẽ thay đổi theo trình tự sau:

Tình trạng đèn	Bắt đầu làm sạch
	sau 1 giờ.
	sau 3 giờ.
	sau 5 giờ.
	Hẹn giờ tự bật được gỡ bỏ.

2. Nhấn nút  NGUỒN (Hình F-8) trên Máy Hút Bụi Tự Động để kích hoạt bộ hẹn giờ tự bật. Máy Hút Bụi Tự Động vào chế độ nghỉ.

Để xóa bộ đếm thời gian ở chế độ chờ, nhấn và giữ nút  NGUỒN (Hình F-8) trên Máy Hút Bụi Tự Động cho đến khi tắt cả đèn chỉ báo tắt, hoặc nhấn nút  TẮT NGUỒN (Hình G-1) trên điều khiển từ xa.

THÔNG BÁO: Nếu trạng thái của cả hai chỉ báo pin bên phải và bên trái là  hoặc , đồng hồ bấm giờ tự động có thể không được kích hoạt và làm sạch có thể không tự động khởi động.

THÔNG BÁO: Các thay đổi về các cài đặt và khởi động vận hành làm sạch không khả thi trong chế độ này

THÔNG BÁO: Cài đặt bộ đếm giờ tự động sẽ bị xóa nếu pin hết hoàn toàn.

Hạn chế Máy Hút Bụi Tự Động vào một khu vực riêng

Băng chắn ranh giới (Hình L-1) và tính năng cảm biến ranh giới sử dụng bộ cảm biến hồng ngoại, cho phép Máy Hút Bụi Tự Động tránh các khu vực sau đây (Hình L-2):

- Một khu vực được chia thành nhiều phần bởi vì toàn bộ sàn là quá lớn đến nỗi Máy Hút Bụi Tự Động không thể làm sạch sàn tại một thời điểm
- Một khu vực mà những đồ để vờ xuất hiện là nơi mà Máy Hút Bụi Tự Động có thể làm hỏng
- Khu vực có nhiều hàng hóa và đồ đạc, rào chắn hoặc vật có Hình dạng phức tạp sẽ làm Máy Hút Bụi Tự Động bị kẹt
- Khu vực lân cận gần cầu thang
- Khu vực có rào chắn thấp mà Máy Hút Bụi Tự Động có thể đi qua và rơi xuống tầng thấp hơn, hoặc Máy Hút Bụi Tự Động sẽ bị mắc kẹt

Chuẩn bị

1. Chọn bề mặt phẳng, nhẵn, trên sàn nhà, nơi bạn sẽ đặt băng chắn ranh giới, và sau đó làm sạch bề mặt.
2. Đặt băng chắn ranh giới sao cho phía bên thanh ngắn là tiếp xúc với khu vực làm sạch và không có bọt không khí giữa băng chắn và sàn nhà.

THÔNG BÁO: Hãy đảm bảo chỉ sử dụng băng chắn ranh giới chính hãng. Sử dụng băng chắn khác ngoài hàng chính hãng có thể có nguy cơ làm hư hỏng tính năng cảm biến ranh giới.

THÔNG BÁO: Không đặt băng chắn ranh giới trên các bề mặt không bằng phẳng vì có thể gây ra phát hiện có sai sót hoặc trên bề mặt nơi băng chắn có thể bị bắn hoặc bị hư hỏng.

THÔNG BÁO: Nên biết rằng một số chất dính có thể vẫn còn trên sàn nhà, hoặc sàn nhà có thể bị hỏng khi bạn tháo băng chắn ranh giới.

THÔNG BÁO: Giữ các băng chắn ranh giới sạch sẽ và kiểm tra nếu có bất kỳ vị trí nào bị xé hoặc bị rách. Nếu băng chắn bị hỏng, thay thế nó.

⚠ CẢNH BÁO: Không đặt băng chắn ranh giới trong khu vực nơi xảy ra tai nạn do Máy Hút Bụi Tự Động di chuyển vào khu vực này hoặc Máy Hút Bụi Tự Động rơi xuống từ khu vực này. Trong trường hợp như vậy, đặt các đồ vật có chiều cao là 15 cm trở lên và đủ nặng để chịu được tác động của Máy Hút Bụi Tự Động ở vị trí của các băng chắn ranh giới.

Vận hành

Khi ở chế độ chờ, nhấn nút  Cảm biến ranh giới (Hình F-11) trên Máy Hút Bụi Tự Động để kích hoạt cảm biến ranh giới (Hình O-2). Đèn (Hình F-11) sáng lên.

Để tắt cảm biến ranh giới, nhấn nút  Cảm biến ranh giới một lần nữa.

THÔNG BÁO: Thiết lập này là không thể trong chế độ tạm nghỉ với đồng hồ bấm giờ tự động được kích hoạt.

BẢO TRÌ

⚠ CHÚ Ý: Luôn đảm bảo rằng cả hai hộp pin được tháo ra trước khi thực hiện kiểm tra hoặc bảo dưỡng.

THÔNG BÁO: Hãy đảm bảo lấy hộp chứa bụi ra trước khi quay Máy Hút Bụi Tự Động để ngăn chặn bụi và chất bẩn rơi ra khỏi bàn chải chính.

THÔNG BÁO: Hãy đảm bảo trải thảm thảm hoặc vật liệu đệm khác trên sàn nhà để tránh hư hỏng sàn nhà và Máy Hút Bụi Tự Động (Hình B).

THÔNG BÁO: Không sử dụng nước nóng (cao hơn 40°C), xăng, ét xăng, dung môi, rượu hoặc các loại tương tự. Có thể dẫn đến đổi màu, biến dạng, hoặc các vết nứt.

Để bảo dưỡng sản phẩm AN TOÀN và ĐÁNG TIN CẬY, việc sửa chữa, bảo dưỡng bất kỳ khác, hoặc điều chỉnh phải được thực hiện bởi Makita Ủy quyền hoặc Trung tâm Dịch vụ Nhà máy, luôn luôn sử dụng các bộ phận thay thế của Makita.

Làm sạch bàn chải mặt bên (Hình A, M-1)

- Sợi chỉ và sợi tóc vướng vào lông bàn chải cạnh có thể làm bàn chải dừng quay. Gỡ bỏ chúng bằng cách sử dụng nhíp hoặc các dụng cụ tương tự.
- Nếu lông bàn chải bị biến dạng hoặc mất, thay thế bằng bàn chải dự phòng (xem “Lắp bàn chải cạnh” để biết chi tiết).

Làm sạch các bánh xe

- Gỡ bỏ sợi chỉ và sợi tóc ra khỏi bánh xe dẫn động (Hình M-2) bằng cách sử dụng các dụng cụ như nhíp và kéo. Quay bánh xe để dễ dàng làm sạch.
- Gỡ bỏ sợi chỉ và sợi tóc ra khỏi bánh xe xoay (Hình M-3) bằng cách sử dụng nhíp, kéo hoặc các dụng cụ tương tự.

THÔNG BÁO: Cần phải cẩn thận để tay của bạn không bị kẹt giữa các bánh xe và thân của Máy Hút Bụi Tự Động.

Làm sạch bàn chải chính

Tháo đai chài cạnh (xem “Lắp bàn chải cạnh” để biết chi tiết) để thực hiện công việc sau.

- Tháo bốn ốc vít (Hình N-1), và sau đó tháo tấm đáy (Hình N-2) và bàn chải chính (Hình N-3).
- Lau sạch tấm đáy (Hình N-2) bằng một miếng vải ẩm với chất tẩy rửa nhẹ hoặc rửa tấm đáy trong nước nếu cần thiết.
- Gỡ bỏ sợi chỉ và sợi tóc ra khỏi bàn chải chính (Hình N-3) bằng nhíp và rửa bàn chải chính trong nước nếu cần thiết.
- Lau sạch bên trong lỗ thông gió chân không (Hình N-4) bằng một miếng vải ẩm với chất tẩy rửa nhẹ.
- Để thay thế bàn chải chính, căn chỉnh phần nhô ra (Hình N-5) trên đầu bên phải của bàn chải chính khớp với phần lõm vào trên bàn chải đẹp bên phải (Hình N-6), và sau đó gắn bàn chải chính vào cùng với nhau.
- Gắn đầu vuông bên trái của bàn chải chính (Hình N-7) bàn chải đẹp vuông bên trái (Hình N-8).
- Thay thế tấm đáy theo trình tự đảo ngược.

LƯU Ý: Khi bàn chải cạnh vẫn gắn với thân của Máy Hút Bụi Tự Động, dùng tay xoay bàn chải cạnh để dễ dàng gắn tấm đáy mà không đè lên lông bàn chải cạnh giữa các tấm và thân của Máy Hút Bụi Tự Động.

Làm sạch cảm biến

- Làm sạch cảm biến mặt dựng (Hình O-1) và các cảm biến ranh giới (Hình O-2) bằng miếng bông khô.
- Làm sạch cảm biến siêu âm (Hình P-1) bằng cách sử dụng máy hút bụi thiết lập ở chế độ hút nhẹ. Tổng cộng có 8 cảm biến được đặt ở mặt trước và hai bên của bộ giảm chấn (Hình P-2).

Làm sạch bộ lọc và hộp chứa bụi

THÔNG BÁO: Để tránh làm hư hỏng nắp hộp chứa bụi phía trên, không mở hoặc đóng bằng lực mạnh.

- Mở hai khóa (Hình Q-1) và nhấn hộp chứa bụi phía trên khi nắm  tay cầm bảo dưỡng bộ lọc (Hình Q-2) để mở ngăn bộ lọc.
- Lấy bộ lọc (Hình Q-3) ra và đập nhẹ vào túi rác hoặc trên một tờ giấy bỏ đi để phủi bụi và chất bẩn.

THÔNG BÁO: Không được lau chùi hoặc cọ rửa bộ lọc, cũng không sử dụng vật nhọn để làm sạch bộ lọc.

- Rửa bộ lọc nếu công suất hút của Máy Hút Bụi Tự Động trở nên yếu.

THÔNG BÁO: Nếu bộ lọc có mùi, ngâm bộ lọc trong thuốc tẩy gia dụng pha loãng (10 ml thuốc tẩy cho mỗi 1 lít nước) khoảng 3 giờ trước khi rửa bộ lọc dưới dòng nước chảy.

- Rửa hộp chứa bụi.
- Phơi khô bộ lọc (nếu bạn đã rửa sạch) và hộp chứa bụi 1 ngày ở nơi thông thoáng để tránh mùi khó chịu hoặc trực trực.

THÔNG BÁO: Không làm khô bộ lọc ướt bằng cách sử dụng máy sấy tóc hoặc các nguồn nhiệt khác.

- Thay thế bộ lọc trong hộp chứa bụi theo trình tự đảo ngược.







THÔNG BÁO: Khi bạn thay thế các bộ lọc trong ngăn, hãy đảm bảo rằng các mẫu (Hình Q-4) trên bộ lọc được lắp vào để chặn cạnh của giá bộ lọc (Hình Q-5).



Làm sạch thân máy

- Lau sạch bên ngoài Máy Hút Bụi Tự Động bằng một miếng vải hơi ẩm với chất tẩy rửa nhẹ.
- Nhấn và thả nắp đầu (Hình K-1), sau đó mở nắp hoàn toàn.
- Lấy hộp chứa bụi ra (Hình K-2).
- Lau sạch bên trong Máy Hút Bụi Tự Động (Hình R-1) bao gồm lỗ thông hơi (Hình R-2) bằng một miếng vải ẩm với chất tẩy rửa nhẹ.

KHÔI PHỤC MÁY HÚT BỤI TỰ ĐỘNG

















Khi Máy Hút Bụi Tự Động không thể tiếp tục vận hành trong điều kiện như bánh xe dẫn động bị rơi ra hoặc nguồn pin bị thoát ra ngoài, Máy Hút Bụi Tự Động sẽ dừng làm sạch và chỉ báo cho bạn biết có trục trặc bằng đèn và còi sau đây.

-  Đèn xử lý sự cố (Hình F-2)
-  Đèn bảo dưỡng bộ lọc (Hình F-3)
-  Đèn bảo dưỡng bàn chải (Hình F-4)
-  Đèn hẹn giờ (Hình F-6)
-  Đèn còi báo (Hình F-9)
-  Đèn chân không (Hình F-10)
-  Đèn cảm biến ranh giới (Hình F-11)

- Nhận biết vấn đề bằng cách sử dụng bảng sau đây.
- Giải quyết vấn đề.
- Nhấn nút  NGUỒN (Hình F-8) trên Máy Hút Bụi Tự Động hoặc  nút Khởi động/Dừng (Hình G-2) trên điều khiển từ xa để chuyển sang chế độ chờ dự phòng.
Đầu hiệu báo lỗi dừng và Máy Hút Bụi Tự Động sẵn sàng làm sạch.

THÔNG BÁO: Nếu xảy ra lỗi một lần nữa, hãy TẮT và BẬT Máy Hút Bụi Tự Động.

THÔNG BÁO: Nếu vấn đề vẫn còn sau khi đã hoàn thành hoạt động sửa chữa, hãy liên hệ Trung tâm Dịch vụ Makita gần nhất.

Chỉ thị	Nguyên nhân/Cách khắc phục
Đèn  nhấp nháy một lần, hai lần, hoặc 6 lần cho mỗi trình tự	<ul style="list-style-type: none"> Bánh truyền động rơi xuống. Máy Hút Bụi Tự Động bị kẹt vào rào chắn. Máy Hút Bụi Tự Động tiếp xúc với ánh sáng mặt trời trực tiếp. Máy Hút Bụi Tự Động đã dừng lại trên một sàn màu đen. <p>→ Di chuyển Máy Hút Bụi Tự Động ra khỏi khu vực. → Nếu xảy ra lỗi một lần nữa, làm sạch cảm biến mặt dựng (Hình O-1).</p>
Đèn  nhấp nháy 3 lần cho mỗi trình tự	<ul style="list-style-type: none"> Đã phát hiện lỗi trong cảm biến bộ giảm chấn. <p>→ Đẩy bộ giảm chấn (Hình P-2) 10 lần.</p>
Đèn  nhấp nháy 4 lần cho mỗi trình tự	<ul style="list-style-type: none"> Sợi chỉ và sợi tóc bị vướng vào bánh xe dẫn động. Gỡ bỏ chúng ra khỏi bánh xe dẫn động (Hình M-2). Máy Hút Bụi Tự Động đi qua khu vực giới hạn nơi mặt trên của máy bị đẩy xuống. <p>→ Đẩy không phải bị trực trực.</p>
Đèn  nhấp nháy 5 hoặc 7 lần cho mỗi trình tự	<ul style="list-style-type: none"> Máy Hút Bụi Tự Động bị quá nhiệt. TẮT Máy Hút Bụi Tự Động, tháo (các) hộp pin, và chờ một giờ. Sử dụng Máy Hút Bụi Tự Động chỉ ở nhiệt độ phòng không quá 40°C.
Đèn  và  nhấp nháy một lần cho mỗi trình tự	<ul style="list-style-type: none"> Hộp chứa bụi hoặc bộ lọc chưa được lắp đặt. <p>→ Lắp đặt hộp chứa bụi và bộ lọc.</p>
Đèn  và tất cả  nhấp nháy một lần cho mỗi trình tự	<ul style="list-style-type: none"> Pin sạc còn lại không đủ ( hoặc ) để khởi động làm sạch. <p>→ Sạc đầy hộp pin.</p>
Đèn  và  sáng lên	<ul style="list-style-type: none"> Sợi chỉ và sợi tóc bị vướng trong bánh xe dẫn động. Gỡ bỏ chúng ra khỏi bánh xe dẫn động (Hình M-2). Máy Hút Bụi Tự Động đi qua khu vực giới hạn nơi mặt trên của máy bị đẩy xuống. <p>→ Đẩy không phải bị trực trực.</p>
Đèn  và  sáng lên	<ul style="list-style-type: none"> Đã phát hiện lỗi trong cảm biến. <p>→ TẮT và sau đó BẬT Máy Hút Bụi Tự Động.</p>
Đèn  và  sáng lên	<ul style="list-style-type: none"> Phát hiện lỗi trong Máy Hút Bụi Tự Động. <p>→ TẮT và sau đó BẬT Máy Hút Bụi Tự Động.</p>
Đèn  nhấp nháy một lần cho mỗi trình tự	<ul style="list-style-type: none"> Sợi chỉ và sợi tóc vướng vào bàn chải cạnh và bàn chải chính. Gỡ bỏ chúng ra khỏi các bàn chải (Hình A, N-3).
Đèn  sáng lên	<ul style="list-style-type: none"> Hộp chứa bụi đầy bụi và chất bẩn hoặc bộ lọc bị tắc. <p>→ Đổ hết hộp chứa bụi (Hình K-2) và làm sạch bộ lọc (Hình K-5).</p>

XỬ LÝ SỰ CỐ

LƯU Ý: Nếu vấn đề vẫn còn sau khi thực hiện hoạt động sửa chữa, hãy liên hệ Trung tâm Dịch vụ Makita gần nhất.

Dấu hiệu	Nguyên nhân/Cách khắc phục
Các đèn không sáng lên khi bạn nhấn nút 	<ul style="list-style-type: none"> Lắp đặt hộp pin đúng cách. Sạc đầy hộp pin. Nhấn nút  để BẬT Máy Hút Bụi Tự Động.
Máy Hút Bụi Tự Động không hoạt động khi bạn nhấn nút trên Máy Hút Bụi Tự Động hoặc điều khiển từ xa.	<ul style="list-style-type: none"> Nếu  đèn xử lý sự cố,  đèn bảo dưỡng bộ lọc, hoặc  đèn báo dưỡng bàn chải sáng lên hoặc nhấp nháy, xem "KHỎI PHỤC MÁY HÚT BỤI TỰ ĐỘNG" để giải quyết vấn đề. Nếu đèn báo nhấp nháy chậm, nhấn và giữ nút  NGUỒN trên Máy Hút Bụi Tự Động cho đến khi tất cả các chỉ báo đều tắt, hoặc nhấn nút  TẮT NGUỒN trên điều khiển từ xa để xóa bộ đếm thời gian.
Máy Hút Bụi Tự Động không hoạt động.	<ul style="list-style-type: none"> Đồng hồ hẹn giờ bật tự động được kích hoạt.
Máy Hút Bụi Tự Động ngưng vận hành trong khi đang làm việc.	<ul style="list-style-type: none"> TẮT Máy Hút Bụi Tự Động, và sau đó tháo các sợi dây, dây bên, v.v... ra khỏi bánh xe dẫn động. Nếu Máy Hút Bụi Tự Động bị kẹt vào rào chắn hoặc vật cản khác, di chuyển Máy Hút Bụi Tự Động đến vị trí khác.
Tốc độ hành trình không ổn định.	<ul style="list-style-type: none"> Nếu phát hiện có vật cản, Máy Hút Bụi Tự Động sẽ chậm lại khi cần thời gian để tính toán hướng đi chuyên. Đây không phải sự cố của Máy Hút Bụi Tự Động.
Máy Hút Bụi Tự Động không đi thẳng về phía trước.	<ul style="list-style-type: none"> TẮT Máy Hút Bụi Tự Động, và sau đó tháo các vật thể lạ bất kỳ ra khỏi bánh xe dẫn động. Làm sạch cảm biến siêu âm.
Máy Hút Bụi Tự Động va chạm vào vật cản thường xuyên hơn so với trước đây.	<ul style="list-style-type: none"> Làm sạch cảm biến siêu âm.
Máy Hút Bụi Tự Động rơi xuống cầu thang hoặc xuống tầng thấp hơn.	<ul style="list-style-type: none"> Làm sạch cảm biến mặt dựng. Máy Hút Bụi Tự Động không thể tránh khỏi chênh lệch ở mức độ 5,5 cm hoặc ít hơn. Đây không phải sự cố của Máy Hút Bụi Tự Động.
Âm thanh vận hành lớn hơn bình thường.	<ul style="list-style-type: none"> Đổ sạch hộp chứa bụi và làm sạch bộ lọc, bàn chải cạnh, và bàn chải chính.
Công suất hút không đủ mạnh để hút bụi và chất bẩn.	<ul style="list-style-type: none"> Đổ sạch hộp chứa bụi và bộ lọc. Nhấn nút  Hút trên Máy Hút Bụi Tự Động hoặc trên điều khiển từ xa để BẬT quạt hút.
Bàn chải cạnh bị rơi ra.	<ul style="list-style-type: none"> Lắp đặt bàn chải cạnh đúng cách (Hình A).
Bàn chải cạnh không xoay hoặc xoay khó.	<ul style="list-style-type: none"> Làm sạch bàn chải cạnh và bàn chải chính. Lắp đặt bàn chải cạnh và các tấm đúng cách (Hình N).
Khí xả có mùi.	<ul style="list-style-type: none"> Đổ sạch hộp chứa bụi và bộ lọc.

Điều khiển từ xa không hoạt động.	<p>→ Lắp đặt pin điều khiển từ xa đúng cách (Hình E).</p> <p>→ Thay thế pin bằng pin mới.</p> <p>→ Nhấn nút  NGUỒN trên Máy Hút Bụi Tự Động để BẬT máy.</p> <p>→ Di chuyển gần với Máy Hút Bụi Tự Động hoặc gỡ bỏ vật cản giữa Máy Hút Bụi Tự Động và điều khiển từ xa.</p> <p>→ Ngưng sử dụng Máy Hút Bụi Tự Động gần hoặc di chuyển máy ra khỏi thiết bị có sử dụng tần số vô tuyến trong dải tần số 2,4 GHz (lò vi sóng, các thiết bị Bluetooth, các thiết bị Wi-Fi, v.v...).</p> <p>→ TẮT và sau đó BẬT Máy Hút Bụi Tự Động.</p>
Đồng hồ hẹn giờ tự động không hoạt động.	<p>→ Sử dụng hộp pin được sạc đầy.</p> <p>→ Kích hoạt đồng hồ hẹn giờ bật tự động.</p>

CÁC PHỤ KIỆN TỰ CHỌN

⚠ CHÚ Ý: Những phụ kiện hoặc phụ tùng được khuyến nghị sử dụng với dụng cụ Makita của bạn được quy định trong hướng dẫn này. Việc sử dụng các phụ kiện hoặc phụ tùng khác có thể dẫn đến nguy cơ thương tích cho con người. Chỉ sử dụng các phụ kiện hoặc phụ tùng với mục đích đã được trình bày.

- Băng chắn ranh giới
- Bàn chải cạnh
- Bàn chải chính
- Tấm đáy
- Bộ lọc
- Pin và bộ sạc chính hãng Makita

LƯU Ý: Một số mặt hàng trong danh sách có thể bao gồm trong gói dụng cụ như các phụ kiện tiêu chuẩn. Chúng có thể khác nhau ở các quốc gia.

THÔNG TIN THAM KHẢO

Tổng công ty Makita và các công ty con, chi nhánh, và nhà phân phối có thể sử dụng Thông tin Cách sử dụng với mục đích dịch vụ sau bán hàng dịch vụ như bảo dưỡng và sửa chữa. Thông tin Cách sử dụng bao gồm số lượng vận hành, tải trọng phân phối, thông tin lỗi, tình trạng hoạt động, và/hoặc hồ sơ bảo dưỡng của các dụng cụ điện.

ภาษาไทย (คำแนะนำฉบับ)

คำเตือน: เครื่องนี้ไม่มีจุดประสงค์เพื่อการใช้งานโดยผู้ที่ (รวมถึงเด็ก) มีสมรรถภาพทางกาย ทางความรู้สึก หรือทางจิตลดลง หรือไม่มีความรู้และประสบการณ์ เด็กควรได้รับการควบคุมดูแลเพื่อไม่ให้เล่นกับเครื่องใช้นี้

ข้อกำหนดเฉพาะ

แบตเตอรี่มาตรฐาน	BL1815N, BL1820B, BL1830B, BL1840B, BL1850B, BL1860B
ระยะเวลาการใช้งานแบตเตอรี่ (ใช้แบตเตอรี่ลิเทียมไอออนที่เป็นอุปกรณ์เสริม)	ประมาณ 120 นาที เมื่อใช้ BL1830 สองชุด (ชุดละ 18 V, 3 Ah) ประมาณ 200 นาที เมื่อใช้ BL1850 สองชุด (ชุดละ 18 V, 5 Ah)
ขนาดถังบรรจุฝุ่น	2.5 ลิตร
ขนาด (กว้าง/ยาว/สูง) (รวมแบตเตอรี่ BL1830)	ประมาณ 460 x 460 x 180 มม.
น้ำหนัก (รวมแบตเตอรี่ BL1830 สองก้อน)	ประมาณ 7.8 กก.

- เนื่องจากเรามีการวิจัยและพัฒนาตลอดเวลา ข้อกำหนดเฉพาะในที่นี้อาจเปลี่ยนแปลงโดยไม่มีการแจ้งให้ทราบ
- ข้อกำหนดเฉพาะอาจแตกต่างกันไปในแต่ละประเทศ

สัญลักษณ์



อ่านคู่มือการใช้งาน



อย่าเหยียบหรือวางวัตถุใดๆ บนหุ่นยนต์ดูดฝุ่น



อย่าใช้งานหุ่นยนต์ดูดฝุ่นใกล้ปลั๊กไฟหรือวัตถุไวไฟและ/หรือวัตถุอันตราย



ทำความสะอาดเซ็นเซอร์กันตกรากที่สูงที่อยู่บริเวณใต้เครื่อง หากสกปรกหรือเปียก

วัตถุประสงค์การใช้งาน

หุ่นยนต์ดูดฝุ่นนี้มีไว้สำหรับใช้ทำความสะอาดพื้นภายในอาคารตัวควบคุมจากระยะไกลจะเชื่อมต่อกับหุ่นยนต์ดูดฝุ่นในแบบไร้สาย (2.4 GHz ZigBee)

ข้อควรระวังเพื่อความปลอดภัย



คำเตือน

ห้ามใช้หุ่นยนต์ดูดฝุ่นใกล้กับ หรือดูดสารไวไฟ การทำเช่นนี้อาจส่งผลให้เกิดการระเบิดหรือไฟไหม้ได้

- น้ำมันก๊าด น้ำมันเชื้อเพลิง รูป เทียน
- น้ำมันเบนซิน ทินเนอร์
- กัญหรี
- ทินเนอร์หรือสารที่ติดไฟได้อื่นๆ
- น้ำยาซักพรมหรือสารที่เป็นเชื้อเพลิงอื่นๆ

ห้ามใช้หุ่นยนต์ดูดฝุ่นในสถานที่เปียก สถานที่ซึ่งอาจเปียกได้ หรือสถานที่ซึ่งมีอุณหภูมิและความชื้นสูง รวมถึงห้ามใช้เพื่อดูดน้ำด้วย

การทำเช่นนี้อาจส่งผลให้ถูกไฟดูด ไฟฟ้าลวดวงจร ไฟไหม้ เกิดการเสียหาย หรือทำงานผิดปกติได้

- ห้องครัวหรือพื้นที่อื่นๆ ซึ่งมีการใช้น้ำ
- ห้องอาบน้ำ
- ห้องอาบน้ำฝักบัว
- ห้องใต้หลังคา ฯลฯ

ห้ามสัมผัสหุ่นยนต์ดูดฝุ่นขณะที่เปียก

การทำเช่นนี้อาจส่งผลให้ถูกไฟดูดได้

ห้ามใช้หุ่นยนต์ดูดฝุ่นรอบบริเวณเคาท์ทอปหรืออุปกรณ์ทำความร้อนอื่นๆ

การทำเช่นนี้อาจส่งผลให้ถูกไฟดูด ไฟฟ้าลวดวงจร ไฟไหม้ เกิดการเสียหาย หรือทำงานผิดปกติได้

ห้ามใช้หุ่นยนต์ดูดฝุ่นในสถานที่ดังต่อไปนี้

การทำเช่นนี้อาจส่งผลให้ถูกไฟดูดหรือได้รับบาดเจ็บได้

- ใกล้เด็กทารกหรือผู้ที่มีสมรรถภาพทางกาย ทางความรู้สึก หรือทางจิตลดลง หรือไม่มีความรู้และประสบการณ์ที่จำเป็น
- ใกล้สัตว์
- ใกล้ฝูงชนหรือพื้นที่ซึ่งมีการจราจรสูง

อย่าอนุญาตให้เด็กที่ไม่มีผู้ดูแล หรือผู้ที่ไม่สามารถแสดงความสามารถของตัวเองหรือใช้งานหุ่นยนต์ดูดฝุ่นด้วยตัวเอง ใช้หุ่นยนต์ดูดฝุ่น

การทำเช่นนี้อาจส่งผลให้ถูกไฟดูดหรือได้รับบาดเจ็บได้

หยุดใช้งานทันทีในกรณีที่เกิดความผิดปกติหรือการทำงานผิดพลาด ดังเช่นในกรณีต่อไปนี้

การไม่ปฏิบัติตามคู่มือการใช้งานอาจส่งผลให้เกิดควันไฟ ไฟไหม้ หรือไฟดูดได้

- หุ่นยนต์ดูดฝุ่นไม่ทำงานแม้เมื่อเปิดสวิตซ์แล้ว
- หุ่นยนต์ดูดฝุ่นเกิดการเสียหายหรือร้อนผิดปกติ
- หุ่นยนต์ดูดฝุ่นหยุดทำงานเป็นครั้งคราวระหว่างการใช้งาน
- หุ่นยนต์ดูดฝุ่นมีเสียงผิดปกติระหว่างการใช้งาน
- หุ่นยนต์ดูดฝุ่นส่งกลิ่นเหม็นไหม้

ปิดหุ่นยนต์ดูดฝุ่นในสถานที่ซึ่งมีการห้ามใช้

การไม่ปฏิบัติตามคู่มือการใช้งานนี้อาจส่งผลให้อุปกรณ์การแพทย์ทำงานไม่ถูกต้อง

ปฏิบัติตามคำแนะนำของสถาบันการแพทย์แต่ละแห่งเสมอเมื่อใช้อุปกรณ์ที่ส่งคลื่นวิทยุในสถานบริการแพทย์

ห้ามใช้หุ่นยนต์ดูดฝุ่นในพื้นที่แคบและพื้นที่สูงที่ไม่มีผนังล้อมรอบ

การทำเช่นนี้อาจเป็นเหตุให้หุ่นยนต์ดูดฝุ่นตกจากพื้นที่ สูงผลให้ได้รับบาดเจ็บหรือการทำงานผิดปกติ

- บันได
- บันไดเตี้ย ขั้วงาน ตู้อินช็อก ตู้เย็น ฯลฯ
- ระเบียง ห้องเพดาน พื้นที่ที่มีทางลงสู่ปล่องบันได หรือประตูทางเข้า ฯลฯ
- สถานที่ซึ่งลาดเอียง 10° หรือมากกว่า

อย่าให้หุ่นยนต์ดูดฝุ่นสัมผัสกับแสงแดดหรือรังสีอินฟราเรดโดยตรง

การทำงานไม่เหมาะสมเนื่องจากความผิดพลาดของเซ็นเซอร์อาจส่งผลให้หุ่นยนต์ดูดฝุ่นชนกหล่นลงมา ทำให้ได้รับบาดเจ็บหรือการทำงานผิดปกติ

- สวิตเซอร์ชาโลเจน
 - รีโมทคอนโทรลหรือเซนเซอร์ ฯลฯ
 - แสงอาทิตย์ที่ลอดผ่านเข้ามาทางกระจกฝ้า
- เคลื่อนย้ายสิ่งของที่อาจก่อให้เกิดอุบัติเหตุในกรณีที่สัมผัสกับหุ่นยนต์ดูดฝุ่น**
 การไม่ปฏิบัติตามคู่มือการใช้งานนี้อาจส่งผลให้ได้รับบาดเจ็บเนื่องจากสะดุดสิ่งของหรือสิ่งของตกหล่นลงมา
- เทียนที่จุดไฟ แก๊สน้ำ ฯลฯ
 - อุปกรณ์อิเล็กทรอนิกส์ที่มีปุ่มควบคุมอยู่ในความสูงระดับใกล้เคียงกับหุ่นยนต์ดูดฝุ่น

ห้ามปกคลุมหุ่นยนต์ดูดฝุ่น

การทำเช่นนี้อาจส่งผลให้ไฟไหม้เนื่องจากความร้อนสูงเกิน **ห้ามยืนบนหรือวางของบนก้นหุ่นยนต์ดูดฝุ่น ห้ามให้ถูกแรงกระแทกอย่างรุนแรง**
 การทำเช่นนี้อาจส่งผลให้ได้รับบาดเจ็บ เครื่องเสียหายหรือทำงานผิดปกติได้ โดยเฉพาะอย่างยิ่ง ให้ใส่ใจอย่างใกล้ชิดต่อเด็กที่อยู่รอบหุ่นยนต์ดูดฝุ่น

ห้ามตัดแปลงหุ่นยนต์ดูดฝุ่นเป็นอันตราย

การทำเช่นนี้อาจส่งผลให้ไฟไหม้ ไฟดูด หรือได้รับบาดเจ็บได้ สำหรับการซ่อมแซม กรุณาปรึกษาตัวแทนจำหน่ายที่คุณซื้อหุ่นยนต์ดูดฝุ่นมา

ห้ามปิดกั้นหรือใส่วัตถุแปลกปลอมที่เป็นโลหะหรือติดไฟง่ายเข้าไปในช่องดูดหรือช่องลมท้ายออก รวมทั้งห้ามใช้หุ่นยนต์ดูดฝุ่นรอบสิ่งของที่อาจปิดกั้นช่องดูดด้วย
 การทำเช่นนี้อาจส่งผลให้เกิดไฟดูด ไฟไหม้ หรือการทำงานผิดปกติได้

อย่าทำให้หุ่นยนต์ดูดฝุ่นร้อนหรือสัมผัสกับไฟ หรือทิ้งไว้ในสถานที่ร้อน เช่น ใกล้ไฟหรือเตา สัมผัสกับแสงแดดโดยตรง หรือทิ้งไว้ในรถท่ามกลางแสงแดดจ้า

การทำเช่นนี้อาจส่งผลให้ไฟฟาสลัดวงจร ไฟไหม้ หรือเป็นเหตุให้แบตเตอรี่ระเบิดหรือมีของเหลวรั่วไหลออกมา

อย่าล้างหรือแช่หุ่นยนต์ดูดฝุ่น* ในน้ำหรือผงซักฟอก
 การทำเช่นนี้อาจส่งผลให้ถูกไฟดูด ไฟฟาสลัดวงจร หรือไฟไหม้ได้

* ยกเว้นแปรงหลัก แผ่นไต่เครื่อง แปรงข้าง กล้องเก็บฝุ่น และถุงกรองฝุ่น

ห้ามสัมผัสกับล้อเลื่อนหรือยื่นมือหรือเท้าเข้าไปใต้หุ่นยนต์ดูดฝุ่นระหว่างการใช้งาน

การทำเช่นนี้อาจส่งผลให้ได้รับบาดเจ็บได้ โดยเฉพาะอย่างยิ่ง ให้ใส่ใจอย่างใกล้ชิดต่อเด็กที่อยู่รอบหุ่นยนต์ดูดฝุ่น

ห้ามปิดกั้นหรือใส่สิ่งแปลกปลอมเข้าไปในเซนเซอร์หุ่นยนต์ดูดฝุ่น

การทำเช่นนี้อาจส่งผลให้การทำงานล้มเหลว ได้รับบาดเจ็บจากหุ่นยนต์ดูดฝุ่นตกหล่นอันเป็นผลจากการใช้งานไม่เหมาะสม หรือการทำงานผิดปกติ

ห้ามปิดเทปที่เซนเซอร์หรือล้อเลื่อน ห้ามปรับเปลี่ยนก้นหรือรูปทรงล้อหรือกดก้นชนด้วยการใช้แรงเกินขนาด

การทำเช่นนี้อาจส่งผลให้การทำงานล้มเหลว ได้รับบาดเจ็บจากหุ่นยนต์ดูดฝุ่นตกหล่นอันเป็นผลจากการใช้งานไม่เหมาะสม หรือการทำงานผิดปกติ

ห้ามนำของมาใส่ในช่องเก็บขยะ
 การไม่ปฏิบัติตามคู่มือการใช้งานนี้อาจส่งผลให้การทำงานล้มเหลว ได้รับบาดเจ็บจากหุ่นยนต์ดูดฝุ่นตกหล่นอันเป็นผลจากการใช้งานไม่เหมาะสม หรือการทำงานผิดปกติ

อย่าใช้เทปกันพื้นที่ (แยกจำหน่าย) ที่สกปรก หลุดลอกออก หรือชำรุด

การทำเช่นนี้อาจส่งผลให้ได้รับบาดเจ็บจากหุ่นยนต์ดูดฝุ่นตกหล่นอันเป็นผลจากการทำงานล้มเหลว

ข้อควรระวัง

ห้ามใช้หุ่นยนต์ดูดฝุ่นในสถานที่ดังต่อไปนี้
 การทำเช่นนี้อาจส่งผลให้เครื่องทำงานไม่เหมาะสม

- ในโรงพยาบาลหรือรอมอุปกรณ์การแพทย์
- ในเครื่องปรับอากาศ
- รอมอุปกรณ์อิเล็กทรอนิกส์ที่ต้องใช้การควบคุมอย่างแม่นยำหรือใช้สัญญาณอ่อน

เก็บหุ่นยนต์ดูดฝุ่นและรีโมทคอนโทรลให้ห่างจากเครื่องกระตุ้นหัวใจแบบฝังในร่างกายและเครื่องกระตุ้นหัวใจไฟฟ้ามากกว่า 15 ซม.

การไม่ปฏิบัติตามคู่มือการใช้งานนี้อาจส่งผลให้อุปกรณ์การแพทย์ทำงานผิดปกติ

อย่าใส่สิ่งแปลกปลอมเข้าไปในช่องว่างหรือช่องเปิดต่างๆ
 การทำเช่นนี้อาจส่งผลให้ถูกไฟดูดหรือได้รับบาดเจ็บได้

ระมัดระวังอย่าให้น้ำมือเข้าไปใต้ขณะทำความสะอาดหุ่นยนต์ดูดฝุ่น

การทำเช่นนี้อาจส่งผลให้ได้รับบาดเจ็บได้

อ่านคู่มือการใช้งานให้ละเอียดก่อนใช้งานหุ่นยนต์ดูดฝุ่น

การไม่ปฏิบัติตามคู่มือการใช้งานนี้อาจส่งผลให้ได้รับบาดเจ็บหรือเกิดการทำงานผิดปกติได้

ข้อสังเกต

หยุดใช้งานตามแถบเตือนที่หากมีกลิ่นในถังประสงค์แบตเตอรี่รีชาร์จ ร้อนผิดปกติ เกิดการเสียบหรือมีการเปลี่ยนสี

การไม่ปฏิบัติตามคู่มือการใช้งานนี้อาจส่งผลให้เกิดการทำงานผิดปกติได้

ห้ามใช้หุ่นยนต์ดูดฝุ่นภายนอกอาคารหรือในสถานที่ซึ่งเครื่องอาจเคลื่อนที่ออกไปนอกรถยนต์

การทำเช่นนี้อาจส่งผลให้เกิดการทำงานผิดปกติได้

ห้ามใช้หุ่นยนต์ดูดฝุ่นในสถานที่ดังต่อไปนี้

การทำเช่นนี้อาจส่งผลให้เกิดการทำงานผิดปกติได้

- สถานที่ซึ่งมีเศษน้ำมันหรือส่วนประกอบอื่นๆ ของน้ำมันลอยอยู่ในอากาศ
- สถานที่ซึ่งมีการไหลของสเปรย์หรือผลิตภัณฑ์เคมี เช่น ไร่ตัดผม ร้านเสริมสวย และร้านซักรีด
- สถานที่ซึ่งมีฝุ่นมาก

ห้ามใช้หุ่นยนต์ดูดฝุ่นในสถานที่ดังต่อไปนี้

การทำเช่นนี้อาจทำให้สิ่งปูพื้นเสียหาย หรือผิวหนังของพื้นเป็นรอยขีดข่วน

- สถานที่ซึ่งสิ่งปูพื้นเสียหายได้ง่าย (หนังแกะ วัสดุที่หาค่าคงผ่านสัตว์ ฯลฯ)
- ไม้ที่ไม่ได้ขัดเงาหรือพื้นหินอ่อน
- พื้นที่เพิ่งลงแว็กซ์

ห้ามใช้หุ่นยนต์ดูดฝุ่นบนสิ่งปูพื้นที่มีความยาวมาก (7 ม. หรือมากกว่า)

การทำเช่นนี้อาจส่งผลให้สิ่งปูพื้นเสียหายหรือเป็นเหตุให้หุ่นยนต์ดูดฝุ่นทำงานผิดปกติ

ห้ามใช้หุ่นยนต์ดูดฝุ่นบนพื้นผิวที่แข็ง ไม่เรียบ เช่น พื้นคอนกรีต ฯลฯ

การทำเช่นนี้อาจส่งผลให้แปรงบิดและล้อเลื่อนสึกหรอเร็วขึ้น

อย่าใช้หุ่นยนต์ดูดฝุ่นกำแพงหรือล้อเลื่อนชำรุด

การทำเช่นนี้อาจส่งผลให้ผิวหนังของพื้นเป็นรอยขีดข่วน หยุดการใช้งานและปรึกษาตัวแทนจำหน่ายที่คุณซื้อหุ่นยนต์ดูดฝุ่นมา

ขจัดเศษทรายที่ติดกับแปรงหลัก แปรงข้าง และล้อเลื่อนออก

การไม่ปฏิบัติตามคู่มือการใช้งานนี้อาจส่งผลให้ผิวหนังของพื้นเป็นรอยขีดข่วนได้

อย่าดูดสิ่งต่อไปนี้

การทำเช่นนี้อาจทำให้หุ่นยนต์ดูดฝุ่นเป็นรอยขีดข่วนหรืออุดตันภายใน หรือส่งผลให้เกิดการทำงานผิดปกติ

- ของเหลวหรือขยะเปียก
- สารเคมีหรือน้ำมัน
- อลูมิเนียม
- พลาสติกแข็ง
- พลาสติกอ่อน
- วัสดุที่เป็นผง
- วัสดุที่เป็นของแข็ง
- วัสดุที่เป็นของแข็ง
- วัสดุที่เป็นของแข็ง

ทำความสะอาดถาดกรองฝุ่นหลังดูดผงละเอียด

(ดูคู่มือการใช้งาน)

การไม่ปฏิบัติตามคู่มือการใช้งานนี้อาจส่งผลให้เกิดการทำงานผิดปกติได้

อย่าใช้หุ่นยนต์ดูดฝุ่นถาดกรองฝุ่นอุดตันหรือเซนเซอร์เป็นสิ่งที่สกปรก

การทำเช่นนี้อาจส่งผลให้เกิดการทำงานผิดปกติได้

อย่าใส่น้ำมันแปรงหมนหรือชิ้นส่วนที่เคลื่อนที่ได้ลงใน

การทำความสะอาดให้ผลให้ผลเสียต่ออายุการใช้งาน

เก็บรักษาเครื่องมือการใช้นี้ไว้

การใช้งานและการดูแลรักษาเครื่องมือที่ใช้แบตเตอรี่

1. ชาร์จไฟกับเครื่องชาร์จที่ระบุโดยผู้ผลิตเท่านั้น เครื่องชาร์จที่เหมาะสมกับแบตเตอรี่ประเภทหนึ่งอาจเสี่ยงต่อการเกิดไฟไหม้ได้เมื่อใช้กับแบตเตอรี่ประเภทอื่น
2. ใช้เครื่องมือไฟฟ้กับแบตเตอรี่ที่กำหนดมาเป็นพิเศษเท่านั้น การใช้แบตเตอรี่แบบอื่นอาจเสี่ยงต่อการบาดเจ็บหรือไฟไหม้ได้
3. เมื่อไม่ได้ใช้งานแบตเตอรี่ ควรเก็บไว้ในที่ห่างจากคลิพหนีบกระดาษ เหรียญ กุญแจ ตะปู สกรู และวัตถุโลหะอื่นที่อาจเกิดการเชื่อมขั้วหนึ่งกับอีกขั้วหนึ่งได้
4. ในสภาวะที่อุณหภูมิสูง อาจมีของเหลวไหลออกมาจากแบตเตอรี่ หลังเลิกใช้การสัมผัสกับของเหลวนี้ หากเกิดการสัมผัสโดยไม่ตั้งใจ ให้ล้างออกด้วยน้ำสะอาด

คำแนะนำเพื่อความปลอดภัยที่สำคัญสำหรับดัลล์แบตเตอรี่

1. ก่อนใช้ดัลล์แบตเตอรี่ ให้อ่านคำแนะนำและสัญลักษณ์การป้องกันไว้ก่อนทั้งหมดบน (1) เครื่องชาร์จแบตเตอรี่ (2) แบตเตอรี่ และ (3) ผลิตภัณฑ์ที่ใช้แบตเตอรี่
2. อย่าถอดชิ้นส่วนประกอบของดัลล์แบตเตอรี่
3. หากระยะเวลาการใช้งานสั้นลงกว่าปกติอย่างเห็นได้ชัด ให้หยุดใช้งานทันที เนื่องจากอาจส่งผลให้ความร้อนสูงเกิน เกิดรอยไหม้ และระเบิดได้
4. หากอิเล็กทรอนิกส์ไหลเข้าตา ให้ล้างออกด้วยน้ำสะอาดและไปพบแพทย์โดยทันที เนื่องจากอาจส่งผลให้ตาบอดได้
5. อย่าใส่ดัลล์แบตเตอรี่:
 - (1) อย่านำให้วัสดุที่เป็นสื่อนำพลังงานสัมผัสกับขั้วแบตเตอรี่
 - (2) หลังเลิกใช้การเก็บดัลล์แบตเตอรี่ไว้ในภาชนะบรรจุที่มีวัตถุโลหะอื่น ๆ เช่น ตะปู เหรียญ ฯลฯ
 - (3) อย่านำให้ดัลล์แบตเตอรี่เปียกน้ำหรือฝนการใส่ดัลล์แบตเตอรี่อาจทำให้มีการไหลของกระแสไฟฟ้าจำนวนมาก ความร้อนสูงเกิน หรือแม้แต่ว่าการชำรุดเสียหายได้

6. อย่าเก็บหุ่นยนต์ดูดฝุ่นและดัลล์แบตเตอรี่ไว้ในสถานที่ซึ่งอุณหภูมิอาจสูงถึงหรือเกิน 50°C
7. อย่าเผาดัลล์แบตเตอรี่เมื่อชำรุดเสียหายอย่างรุนแรง หรือใช้งานไม่ได้แล้ว ก่อนแบตเตอรี่อาจระเบิดในเปลวไฟได้
8. ระงับอย่าให้ดัลล์แบตเตอรี่ตกลงหรือถูกแรงกระแทก
9. อย่าใช้ดัลล์แบตเตอรี่ที่ชำรุดเสียหาย
10. ปฏิบัติตามกฎระเบียบในท้องถิ่นเกี่ยวกับการกำจัดดัลล์แบตเตอรี่

เก็บรักษาเครื่องมือการใช้นี้ไว้

⚠️ ข้อควรระวัง: ใช้แต่แบตเตอรี่ของแท้ของ Makita เท่านั้น การใช้แบตเตอรี่ที่ไม่ใช่ของแท้ของ Makita หรือแบตเตอรี่ที่ผ่านการดัดแปลงแก้ไข อาจส่งผลให้แบตเตอรี่ระเบิด ทำให้เกิดไฟไหม้ ร่างกายได้รับบาดเจ็บ และความเสียหาย รวมทั้งยังทำให้การรับประกันเครื่องมือและเครื่องชาร์จจาก Makita เป็นโมฆะด้วย

เคล็ดลับสำหรับการยืดอายุการใช้งานแบตเตอรี่

1. ชาร์จแบตเตอรี่ก่อนที่จะหมดประจุ หยุดการใช้งานและชาร์จแบตเตอรี่เสมอเมื่อเห็นว่าเครื่องมือกำลังอ่อนลง
2. ห้ามชาร์จแบตเตอรี่ที่ชาร์จเต็มแล้วซ้ำอีก การชาร์จมากเกินไปอาจทำให้อายุการใช้งานแบตเตอรี่สั้นลงได้
3. ชาร์จแบตเตอรี่ในช่วงอุณหภูมิห้องที่ 10°C - 40°C ปล่อยให้แบตเตอรี่เย็นลงก่อนที่จะชาร์จ
4. ชล่อนนำให้ชาร์จแบตเตอรี่แต่ครั้งก่อนจัดเก็บไว้เป็นเวลานาน (มากกว่าหกเดือน)

ระบบป้องกันเครื่อง/ดัลล์แบตเตอรี่

หุ่นยนต์ดูดฝุ่นมีระบบป้องกันเครื่อง/ดัลล์แบตเตอรี่ที่จะตัดไฟมอเตอร์โดยอัตโนมัติเพื่อยืดอายุการใช้งานของหุ่นยนต์ดูดฝุ่นและดัลล์แบตเตอรี่ หุ่นยนต์ดูดฝุ่นจะหยุดทำงานโดยอัตโนมัติในสภาพต่อไปนี้

การะสูงเกิน

หุ่นยนต์ดูดฝุ่นมีการะสูงเกินและต้องมีการใช้กระแสไฟฟ้ามากเกินไป หุ่นยนต์ดูดฝุ่นจะหยุดทำงานโดยไม่มีการบ่งชี้ใดๆ หากต้องการเริ่มการทำงานของหุ่นยนต์ดูดฝุ่นใหม่ ให้ปิดสวิตช์เครื่อง กำจัดต้นเหตุของการมีการะสูงเกิน และเปิดสวิตช์เครื่องอีกครั้ง

ความร้อนสูงเกิน

เมื่อหุ่นยนต์ดูดฝุ่นมีความร้อนสูงเกิน ไฟ **⚠️** จะกะพริบ 5 หรือ 7 ครั้งตามลำดับต่อเนื่องกัน และหุ่นยนต์ดูดฝุ่นจะหยุดทำงานโดยอัตโนมัติ ในกรณีนี้ ปล่อยให้หุ่นยนต์ดูดฝุ่นเย็นลงก่อนที่จะเปิดสวิตช์เครื่องอีกครั้ง











คายประจุจากเก็บ

เมื่อมีแบตเตอรี่เหลืออยู่น้อย หุ่นยนต์ดูดฝุ่นจะหยุดทำงานโดยอัตโนมัติ และไม่ตอบสนองต่อการทำงานของสวิตช์ใดๆ ในกรณีนี้ ให้ถอดดัลล์แบตเตอรี่ออกและนำไปชาร์จ







ปุ่มต่างๆ และไฟแสดงสถานะ

สามารถดูรายละเอียดเกี่ยวกับชิ้นส่วนต่างๆ ได้โดยค้นหาหมายเลขรุ่นที่ตรงกับแต่ละชิ้นส่วนในเอกสารนี้ (เช่น หา "รูป F-8" สำหรับปุ่ม POWER **⏻**)

หุ่นยนต์ดูดฝุ่น (รูป F)

1. ไฟนำทาง
2.  ไฟการแก้ไขปัญหาเบื้องต้น
3.  ไฟการบำรุงรักษาของกรองฝุ่น
4.  ไฟการบำรุงรักษาแปรง
5.  ไฟแสดงสถานะแบตเตอรี่ (สำหรับดัดแปลงแบตเตอรี่ ขั้วมือและขั้วมือ)
6.  ปุ่มและไฟตั้งเวลา
7.  ปุ่มและไฟโหมดเคลื่อนที่
Pi : โหมดรูปแบบ
IX : โหมดสุ่ม
8.  ปุ่ม POWER (เริ่ม/หยุด)
9.  ปุ่มและไฟเสียงกริ่ง
10.  ปุ่มและไฟดูดฝุ่น
11.  ปุ่มและไฟเซนเซอร์ตรวจจับแนวพื้นที่

รีโมทคอนโทรล (รูป G)

1.  ปุ่ม POWER OFF
2.  ปุ่มเริ่ม/หยุด
3.  ปุ่มไฟบอกตำแหน่ง
4. Pi / IX ปุ่มโหมดเคลื่อนที่
5.  ปุ่มตั้งเวลา
6.  ปุ่มเสียงกริ่ง
7.  ปุ่มดูดฝุ่น

ก่อนการใช้งาน

การประกอบและการติดตั้งแบตเตอรี่

⚠️ ข้อควรระวัง: ตรวจสอบให้แน่ใจเสมอว่าได้ปิดหุ่นยนต์ดูดฝุ่นก่อนที่จะยกออกไปหรือทำงานใดๆ กับหุ่นยนต์ดูดฝุ่น

อุปกรณ์เสริมที่ใหม่ล่าสุด

ตรวจสอบว่ามีรายการต่อไปนี้มาใหม่ในบรรจุภัณฑ์

- แบตเตอรี่ขนาด AAA (LR03) (x2)
- แปรงข้าง (x4 รวมแปรงสำรองสองอัน)
- สกรูสำหรับติดตั้งแปรงข้าง (x4)
- เทปกันพื้นที่ (15 ม. x1)
- คู่มือการใช้งาน (x1)
- คู่มือเริ่มต้นใช้งานฉบับย่อ (x1)
- หมายเลขเกี่ยวกับการใช้งาน (x1)

การติดตั้งแปรงข้าง (รูป A)

ติดตั้งแปรงข้างที่ทั้งสองด้านของท้ายด้านหน้าของหุ่นยนต์ดูดฝุ่น

ข้อสังเกต: ก่อนทำงาน ให้ปิดพรมหรือเบาะรองประเภทอื่น ๆ บนพื้นที่เพื่อป้องกันไม่ให้เกิดความเสียหายแก่พื้นและหุ่นยนต์ดูดฝุ่น (รูป B)

1. วางแปรงข้างบนหัวแกนหมุนบนหุ่นยนต์ดูดฝุ่นโดยให้ร่องบนแปรงสวมเข้าสายที่ติดกับหัวแกน
2. ยึดแปรงข้างไว้ให้แน่นโดยใช้สกรูที่ใหม่

ข้อสังเกต: ตรวจสอบให้แน่ใจว่าหุ่นยนต์ดูดฝุ่นทำงานโดยมีแปรงข้างติดตั้งไว้

การติดตั้งดัดแปลงแบตเตอรี่

จัดให้ร่อง (รูป C-2) บนดัดแปลงแบตเตอรี่ตรงกับสัน (รูป C-3) บนที่เสียบแบตเตอรี่แล้วเลื่อนให้เข้าที่ ใส่เข้าไปจนสุดจนกระทั่งล็อกเข้าที่และไม่มีเสียงดังคลิกเบาๆ

หากคุณมองเห็นไฟสีแดง (รูป C-1) ที่ด้านบนของปุ่มปลด แสดงว่าดัดแปลงแบตเตอรี่ยังไม่ล็อกเข้าที่ดี

⚠️ ข้อควรระวัง: ต้องใช้ความระมัดระวังในการติดตั้งดัดแปลงแบตเตอรี่เพื่อไม่ให้นิ้วเข้าไปติดกับที่เสียบแบตเตอรี่และดัดแปลงแบตเตอรี่

หุ่นยนต์ดูดฝุ่นทำงานเมื่อมีดัดแปลงแบตเตอรี่เสียบแล้วติดตั้งที่ด้านใดด้านหนึ่งของที่เสียบแบตเตอรี่เท่านั้น

ในการถอดดัดแปลงแบตเตอรี่ออก ให้เลื่อนออกจากที่เสียบแบตเตอรี่พร้อมทั้งกดปุ่มปลด (รูป D-1) บนดัดแปลง

การใส่แบตเตอรี่ในรีโมทคอนโทรล (รูป E)

เลื่อนฝาปิดของใส่แบตเตอรี่ออก แล้วใส่แบตเตอรี่ขนาด AAA (LR03) สองก้อน ระวังให้ขั้วตรงกัน (+/-)





ข้อสังเกต: อย่าใช้แบตเตอรี่เก่าปนกับแบตเตอรี่ใหม่ หรือใช้แบตเตอรี่คนละประเภทกัน

ข้อสังเกต: ถอดแบตเตอรี่ออก ถ้าจะไม่ใช้รีโมทคอนโทรลเป็นเวลานานๆ

⚠️ ข้อควรระวัง: หากผิวหนังหรือดวงตาสัมผัสกับอิเล็กโทรไลต์ที่รั่วออกจากแบตเตอรี่ ให้ล้างออกด้วยน้ำสะอาดทันที

การจับคู่หุ่นยนต์ดูดฝุ่นกับรีโมทคอนโทรล

หุ่นยนต์ดูดฝุ่นมาพร้อมกับการจับคู่กับรีโมทคอนโทรลแล้ว อย่างไรก็ตาม จะต้องทำการจับคู่อีกครั้งหากเปลี่ยนรีโมทคอนโทรลเป็นอันใหม่

1. กดปุ่มตั้งเวลา  (รูป F-6) และปุ่มโหมดเคลื่อนที่  (รูป F-7) บนหุ่นยนต์ดูดฝุ่นค้างไว้พร้อมกันจนกระทั่งเสียงกริ่งดังขึ้นสองครั้ง
2. กดปุ่มตั้งเวลา  (รูป G-5) และปุ่มไฟบอกตำแหน่ง  (รูป G-3) บนรีโมทคอนโทรลค้างไว้พร้อมกันจนกระทั่งเสียงกริ่งดังขึ้นหนึ่งครั้ง

หากการจับคู่มิแล้วและเสียงกริ่งดังขึ้น 5 ครั้ง ให้ลองจับคู่อีกครั้ง

การจัดห้อง

เพื่อการเคลื่อนที่อย่างราบรื่น

- ปิดประตูเข้าสู่ห้อง หากระดับขอบประตูไม่แตกต่างกันมากและหุ่นยนต์ดูดฝุ่นสามารถผ่านได้โดยไม่มีปัญหา ก็สามารถเปิดประตูทิ้งไว้ เพื่อให้หุ่นยนต์ดูดฝุ่นเคลื่อนที่ไปทำความสะอาดห้องที่อยู่ติดกันได้
- วางสิ่งกีดขวางไว้หน้าเฟอร์นิเจอร์ที่ซาร์ตได้ง่าย ฯลฯ
- วางสิ่งกีดขวางไว้เพื่อป้องกันไม่ให้หุ่นยนต์ดูดฝุ่นเข้าไปในสถานที่ซึ่งอาจติดได้ เช่น ใต้ชั้นวางเตียง
- ย้ายสิ่งของที่สูง ผอม และไม่นั่นคง และสิ่งของอื่นๆ ที่สามารถสะดุดได้ง่ายไปยังห้องอื่น
- ล็อกล้อรถเข็นหรือสิ่งของอื่นๆ หรือย้ายไปยังห้องอื่น
- เก็บสายไฟตามแนวผนังให้เป็นระเบียบ
- ย้ายเบาะ หนังสือ หรือสิ่งของอื่นๆ ที่อาจกีดขวางหุ่นยนต์ดูดฝุ่นไม่ให้เคลื่อนที่ไปยังห้องอื่น
- ยกม่านหรือสิ่งของอื่นๆ ที่ห้อยลงบนพื้นขึ้น
- ย้ายสิ่งปูพื้นที่มีสายที่ติดออกมา หรือมีความหนาไม่มาก และเลื่อนได้ง่ายไปยังห้องอื่น
- พับฟลิปปูพื้นไว้ใต้สิ่งปูพื้น
- เก็บสิ่งของชิ้นเล็กหรือราคาแพงที่อาจถูกดูดได้ง่ายให้พ้นทาง
- เก็บสายไฟ เข็มขัด เข็มขัด กระดาษบาง หรือถุงพลาสติกที่อยู่บนพื้นให้พ้นทาง
- ม้วนเก็บปลั๊กไฟบนพื้นที่สามารถม้วนเก็บสายไฟได้

- ปกคลุมตะแกรงที่แบ่งส่วนต่างๆ ของพื้นด้วยไม้กระดาน ฯลฯ เนื่องจากหุ่นยนต์ดูดฝุ่นอาจตรวจพบว่าเป็นแนวกันและไม่สามารถเคลื่อนที่ผ่านไปได

การป้องกันไม่ให้หุ่นยนต์ดูดฝุ่นตก

- หากพื้นที่ที่ทำความสะอาดมีขั้นบันไดหรือส่วนอื่นๆ ที่หุ่นยนต์ดูดฝุ่นอาจตกลงมาได้ เพื่อให้หุ่นยนต์ดูดฝุ่นไม่เข้าไปในส่วนนั้น ให้วางสิ่งของสูง 15 ซม. ขึ้นไป และหนักพอที่จะทนต่อแรงกระแทกของหุ่นยนต์ดูดฝุ่นไว้หน้าส่วนนั้น
- ปิดกันแสงแดดและรังสีอินฟราเรดด้วยผ้าม่าน (หุ่นยนต์ดูดฝุ่นอาจตกลงมาข้างล่างเมื่อถูกแสงเพื่อหลีกเลี่ยงแสงแดดหรือรังสีอินฟราเรด)
- ปิดครอบประตูลูมิเนียม (หุ่นยนต์ดูดฝุ่นอาจตรวจไม่พบความแตกต่างระหว่างระตังทรงครอบลูมิเนียมและพื้นและอาจตกออกนอกประตู)
- ย้ายสิ่งปูพื้นที่มีความหนาจากพื้นไม้มากไปยังห้องอื่น (หุ่นยนต์ดูดฝุ่นอาจตรวจไม่พบความแตกต่างและอาจตกได้)

หมายเหตุ

- ห้ามใช้หุ่นยนต์ดูดฝุ่นใกล้กับ หรือติดสารไวไฟ (เนื่องจากอาจส่งผลให้เกิดการระเบิดหรือไฟไหม้ได้)
- ห้ามใช้หุ่นยนต์ดูดฝุ่นในสถานที่เปียก สถานที่ซึ่งอาจเปียกได้ หรือสถานที่ซึ่งมีอุณหภูมิและความชื้นสูง รวมทั้งห้ามใช้เพื่อจุดน้ำด้วย (การทำเช่นนี้อาจส่งผลให้เกิดไฟดูดไฟฟ้าลัดวงจร ไฟไหม้ เกิดการเสียรูป หรือทำงานผิดปกติได้)
- ห้ามใช้หุ่นยนต์ดูดฝุ่นในสถานที่ซึ่งระยะห่างจากผนังถึงความแตกต่างของระดับอยู่ที่ประมาณ 1 ม. หรือน้อยกว่า (ในกรณีที่เกิดรอยมาก หุ่นยนต์ดูดฝุ่นอาจตกได้ขณะถอยหลัง)
- ห้ามใช้หุ่นยนต์ดูดฝุ่นในพื้นที่ซึ่งแนวกันที่หุ่นยนต์ดูดฝุ่นไม่สามารถขึ้นข้ามได้อยู่ในพื้นที่ใกล้เคียงกับผนังหรือสิ่งกีดขวาง หุ่นยนต์ดูดฝุ่นอาจติดกับแนวกันขณะถอยหลังเพื่อหลีกเลี่ยงผนังหรือสิ่งกีดขวาง
- ปิดระบบการรักษาความปลอดภัยในบ้าน ฯลฯ (หุ่นยนต์ดูดฝุ่นอาจเข้าใจผิดคิดว่าเป็นผู้บุกรุก)
- หุ่นยนต์ดูดฝุ่นอาจไม่หลีกเลี่ยงระดับที่แตกต่างกัน 5.5 ซม. หรือน้อยกว่า
- อาจมีจุดรวมความปรากฏขึ้นบนจอทีวีขณะใช้งาน (นี่ไม่ใช่การทำงานผิดปกติของโทรทัศน์)
- อย่าปล่อยหุ่นยนต์ดูดฝุ่นทิ้งไว้เป็นเวลานานๆ โดยใส่คอล์มแบตเตอรี่ไว้ (อิเล็กทรอนิกส์ในแบตเตอรี่อาจรวบรัด)
- อย่าวางหุ่นยนต์ดูดฝุ่นกลับด้านเมื่อใส่คอล์มแบตเตอรี่ไว้ (อย่าถูกลูกกด ส่งผลให้เครื่องทำงานโดยไม่ตั้งใจ)

การใช้งาน

หุ่นยนต์ดูดฝุ่นจะเคลื่อนที่ไปรอบๆ พื้นตามโหมดเคลื่อนที่ซึ่งกำหนดไว้ล่วงหน้า โดยจะหลีกเลี่ยงสิ่งกีดขวางโดยใช้เซนเซอร์อัลตราโซนิก (รูป P-1) และเก็บฝุ่นและสิ่งสกปรก รวมถึงขยะอื่นๆ ตามเส้นทางโดยใช้แปรงข้าง แปรงหลัก และพัดลมดูดฝุ่น อย่างไรก็ตาม เซนเซอร์อาจตรวจไม่พบสิ่งกีดขวางในบางสถานการณ์ หากหุ่นยนต์ดูดฝุ่นของคุณชนกับสิ่งกีดขวางกันชนหุ่นยนต์ดูดฝุ่น (รูป P-2) จะดูดซับแรงกระแทกและเปลี่ยนเส้นทางการเดินทาง

หมายเหตุ: อาจมีหลายกรณีที่หุ่นยนต์ดูดฝุ่นไม่อาจข้ามผ่านแนวกันที่สูงถึง 1.5 ซม. แม้หุ่นยนต์ดูดฝุ่นจะได้รับการออกแบบมาให้ข้ามผ่านแนวกันดังกล่าวก็ตาม

หมายเหตุ: หุ่นยนต์ดูดฝุ่นอาจหลีกเลี่ยงบริเวณที่มีสีดำ ไม้ลายไม้สีดำ หรือพื้นที่ซึ่งห่างจากกระจก

หมายเหตุ: หลังเสร็จสิ้นรอบการทำงานทำความสะอาด อาจยังคงมีฝุ่นและสิ่งสกปรกหลงเหลืออยู่บ้างในบางสถานการณ์

หมายเหตุ: การสื่อสารไร้สายอาจถูกขัดจังหวะหรือถูกปิดกั้นภายใต้เงื่อนไขต่อไปนี้:







- ในโครงสร้างซึ่งมีคอนกรีตเสริมเหล็ก หรือวัสดุก่อสร้างที่เป็นโลหะ
- เมื่อหุ่นยนต์ดูดฝุ่นอยู่หลังสิ่งกีดขวาง
- ใกล้อุปกรณ์สื่อสารวิทยุที่ใช้แถบความถี่เดียวกัน
- ใกล้อุปกรณ์ที่สร้างสนามแม่เหล็ก (เตาอบไมโครเวฟ ฯลฯ) หรือไฟฟ้าสถิต หรืออุปกรณ์ที่รบกวนคลื่นวิทยุ

การใช้งานเบื้องต้น

⚠️ ข้อควรระวัง: ตรวจสอบให้แน่ใจอยู่เสมอว่าได้ปิดหุ่นยนต์ดูดฝุ่นก่อนปรับหรือตรวจสอบการทำงานใดๆ ของหุ่นยนต์ดูดฝุ่น



ข้อสังเกต: หากเกิดการกัณตัวของหุ่นยนต์ ให้ปิดหุ่นยนต์ดูดฝุ่นแล้วรอนกระทั้งหุ่นยนต์ดูดฝุ่นแห่ง ก่อนที่จะเริ่มใช้งานอีกครั้ง

ข้อสังเกต: การตั้งค่าทั้งหมดจะไม่ถูกล้างเมื่อปิดหุ่นยนต์ดูดฝุ่น ตรวจสอบให้แน่ใจว่าได้ยืนยันว่าการตั้งค่าถูกต้องแล้วด้วยไฟต่างๆ (รูป F-6, 7, 9, 11) บนหุ่นยนต์ดูดฝุ่นเพื่อป้องกันการทำงานที่ไม่คาดคิด

1. กดปุ่ม  POWER (รูป F-8) บนหุ่นยนต์ดูดฝุ่น หุ่นยนต์ดูดฝุ่นจะเข้าสู่โหมดสแตนด์บายและไฟแสดงสถานะแบตเตอรี่  (รูป F-5) จะสว่างขึ้น (ดูรายละเอียดที่ “ไฟแสดงสถานะแบตเตอรี่บนหุ่นยนต์ดูดฝุ่น” ด้านล่าง)
2. กดปุ่มโหมดเคลื่อนที่  (รูป F-7) บนหุ่นยนต์ดูดฝุ่นซ้ำหลายๆ ครั้งเพื่อเลือกโหมด หรือกด  ปุ่มโหมดเคลื่อนที่ (รูป G-4) บนรีโมทคอนโทรล ไฟโหมดที่เลือกจะสว่างขึ้น (ดูรายละเอียดที่ “โหมดเคลื่อนที่” ด้านล่าง)
3. กดปุ่ม  POWER (รูป F-8) บนหุ่นยนต์ดูดฝุ่น หรือปุ่ม  เริ่ม/หยุด (รูป G-2) บนรีโมทคอนโทรลเพื่อเริ่มการทำงานทำความสะอาด ไฟนำทาง (รูป F-1) กระพริบและเสียงกริ่งจะดังขึ้นขณะทำความสะอาด

หากต้องการหยุดการทำงานสะอาด ให้ทำขั้นตอนที่ 3 ซ้ำอีกครั้ง

หากต้องการเริ่มทำความสะอาดต่อ ให้ทำขั้นตอนที่ 3 ซ้ำอีกครั้ง

หากต้องการปิดหุ่นยนต์ดูดฝุ่น ให้กดปุ่ม  POWER (รูป F-8) บนหุ่นยนต์ดูดฝุ่นค้างไว้จนกระทั่งไฟแสดงสถานะทั้งหมดดับลงแล้ว หรือกดปุ่ม  POWER OFF (รูป G-1) บนรีโมทคอนโทรล

⚠️ ข้อควรระวัง: อย่าวางที่ไฟนำทางใกล้ๆ หรือหลีกเลี่ยงไม่ให้แสงไฟเข้าตา การทำเช่นนั้นอาจเป็นอันตรายต่อดวงตาของคุณได้

ไฟแสดงสถานะแบตเตอรี่บนหุ่นยนต์ดูดฝุ่น

ไฟแสดงสถานะบนด้านที่ตรงกันของคอล์มแบตเตอรี่จะสว่างขึ้นและบ่งบอกถึงพลังงานที่เหลืออยู่ของคอล์มแบตเตอรี่

ข้อสังเกต: ตารางด้านล่างเป็นการบ่งบอกคร่าวๆ ถึงพลังงานแบตเตอรี่ที่เหลืออยู่ จำนวนที่เหลืออยู่อาจแตกต่างกันไปตามเงื่อนไขการใช้งานและอุณหภูมิห้อง

	50% หรือมากกว่า
	ระหว่าง 20% และ 50%
	20% หรือน้อยกว่า
	ว่างเปล่า/ไม่ไดตติงค์ดับแบตเตอรี่
	ข้อผิดพลาดของแบตเตอรี่

ไฟแสดงสถานะแบตเตอรี่บนตัวแบตเตอรี่

สามารถตรวจสอบพลังงานที่เหลือได้โดยใช้ไฟแสดงสถานะแบตเตอรี่ (รูป I-1) บนตัวแบตเตอรี่ซึ่งหมายเลขรุ่นลงท้ายด้วยตัวอักษร "B"

ถอดตัวแบตเตอรี่ออกแล้วกดปุ่ม (รูป I-2)

ข้อสังเกต: ตารางด้านล่างเป็นการบ่งบอกคร่าวๆ ถึงพลังงานแบตเตอรี่ที่เหลืออยู่ จำนวนที่เหลืออยู่อาจแตกต่างกันไปตามเงื่อนไขการใช้งานและอุณหภูมิห้อง

	75% หรือมากกว่า
	ระหว่าง 50% และ 75% (รวม 50%)
	ระหว่าง 25% และ 50%
	25% หรือน้อยกว่า
	ว่างเปล่า
	ข้อผิดพลาดของแบตเตอรี่

โหมดเคลื่อนที่

<input type="checkbox"/> โหมดรูปแบบ	การใช้งาน: บนพื้นที่ขนาดใหญ่ที่มีสิ่งกีดขวางน้อย เช่น คลังสินค้าที่จัดเป็นระเบียบ และเฉลี่ยทางเดินยาว คำอธิบาย (รูป H-1): หุ่นยนต์ดูดฝุ่นจะทำรอบการเดินทางแนวตั้ง (a) และแนวอน (b)*
<input checked="" type="checkbox"/> โหมดสม	การใช้งาน: บนพื้นที่ที่มีสิ่งกีดขวางมาก เช่น ในสำนักงาน คำอธิบาย (รูป H-2): หุ่นยนต์ดูดฝุ่นจะทำรอบการเดินทางแบบกระดิ่งขึ้น (c) และไปตามแนวผนัง (d)

* ทั้งนี้ขึ้นอยู่กับสถานะที่เผชิญ เส้นทางเคลื่อนที่จริงของหุ่นยนต์ดูดฝุ่นอาจแตกต่างจากในแผนผังนี้

หมายเหตุ: หุ่นยนต์ดูดฝุ่นไม่สามารถทำความสะอาดพื้นที่แคบซึ่งหุ่นยนต์ดูดฝุ่นไม่สามารถเข้าถึงได้ หรือที่ปร่งขวางไม่สามารถเข้าถึงได้

หมายเหตุ: หลังรอบการทำทำความสะอาดสิ้นสุดลง อาจยังมีฝุ่นหลงเหลืออยู่บนพื้นบ้างในบางสภาวะการผล

โหมดสลีป

ถ้าเปิดหุ่นยนต์ดูดฝุ่นทิ้งไว้ในโหมดสแตนด์บายเป็นเวลาประมาณ 5 นาที หุ่นยนต์ดูดฝุ่นจะเข้าสู่โหมดสลีปโดยอัตโนมัติเพื่อประหยัดแบตเตอรี่ และไฟนำทาง (รูป F-1) จะกะพริบซ้ำๆ หุ่นยนต์ดูดฝุ่นยังจะเข้าสู่โหมดสลีปด้วยเมื่อเปิดใช้งานตั้งเวลาเปิดอัตโนมัติ

หากต้องการกลับสู่โหมดสแตนด์บาย ให้ทำขั้นตอน 3 ใน "การใช้งานเบื้องต้น"

ข้อสังเกต: ไม่สามารถเปลี่ยนแปลงการตั้งค่าและเริ่มการทำทำความสะอาดได้ในโหมดนี้

การยกหุ่นยนต์ดูดฝุ่น

ข้อควรระวัง: ก่อนยกหุ่นยนต์ดูดฝุ่น ให้ปิดหุ่นยนต์ดูดฝุ่นก่อนเสมอ

ข้อควรระวัง: ต้องระมัดระวังไม่ให้มือเข้าไปติดระหว่างหูจับและตัวเครื่องหุ่นยนต์ดูดฝุ่น

จับที่หูจับ (รูป J-1)

ข้อสังเกต: หากคุณใช้มือรองท้ายด้านหลังของหุ่นยนต์ดูดฝุ่น ต้องระมัดระวังที่จะไม่ยกตัวนั้นมากเกินไปเนื่องจากฝุ่นและสิ่งสกปรกในหุ่นยนต์ดูดฝุ่นจะหล่นออกจากรูปรังหลัก

ข้อสังเกต: ห้ามลากหุ่นยนต์ดูดฝุ่น

การเทฝุ่นออกจากถัง

เทฝุ่นออกจากถังหลังการใช้งานทุกครั้งเพื่อให้หุ่นยนต์ดูดฝุ่นทำงานเต็มประสิทธิภาพ

- กดปุ่ม POWER (รูป F-8) บนหุ่นยนต์ดูดฝุ่นค้างไว้จนกระทั่งไฟแสดงสถานะทั้งหมดดับลง หรือกดปุ่ม POWER OFF (รูป G-1) บนรีโมทคอนโทรลเพื่อปิดหุ่นยนต์ดูดฝุ่น
- กดและปลดฝาบน (รูป K-1) เพื่อปลดล็อก จากนั้นเปิดฝาให้อ้าออกจนสุด
- นำกล่องเก็บฝุ่นออกมา (รูป K-2)
- ปลดล็อกทั้งสองด้าน (รูป K-3) และเปิดฝากล่องเก็บฝุ่น
- นำถังบนออกมาและเทฝุ่นออก (รูป K-4)
- นำก้อนฝุ่นออกจากถังกองฝุ่น (รูป K-5) และเทฝุ่นในถังล่าง (รูป K-6)
- ใส่กล่องเก็บฝุ่นในหุ่นยนต์ดูดฝุ่นตามลำดับย้อนกลับ

การใช้งานขั้นสูง

สามารถตั้งค่าคุณลักษณะต่อไปนี้ได้เมื่อหุ่นยนต์ดูดฝุ่นอยู่ในโหมดสแตนด์บายเท่านั้น (ดูขั้นตอนที่ 1 ใน "การใช้งานเบื้องต้น")

การประหยัดพลังงาน

หุ่นยนต์ดูดฝุ่นสามารถเก็บฝุ่นที่มองเห็นได้ส่วนใหญ่โดยไม่ต้องใช้พัดลมดูดฝุ่น หากไม่จำเป็นต้องกำจัดฝุ่นละเอียด การปิดพัดลมดูดฝุ่นจะช่วยประหยัดพลังงานเพื่อยืดเวลาการใช้งานหุ่นยนต์ดูดฝุ่นให้นานขึ้น

ในโหมดสแตนด์บาย กดปุ่มดูดฝุ่น บนหุ่นยนต์ดูดฝุ่น (รูป F-10) หรือบนรีโมทคอนโทรล (รูป G-7) เพื่อปิดไฟดูดฝุ่น (รูป F-10)

หากต้องการเปิดพัดลมดูดฝุ่น กดปุ่มดูดฝุ่น บนหุ่นยนต์ดูดฝุ่น (รูป F-10) หรือบนรีโมทคอนโทรล (รูป G-7) ไฟจะสว่างขึ้นอีกครั้ง

ข้อสังเกต: การตั้งค่านี้ทำไม่ได้ในโหมดสลีปเมื่อเปิดใช้งานตั้งเวลาเปิดอัตโนมัติ

ข้อสังเกต: ในกรณีที่พัดลมดูดฝุ่นปิด ไฟการบำรุงรักษาถังกองฝุ่น (รูป F-3) จะไม่ติดสว่างแม้เมื่อถังกองฝุ่นมีฝุ่นอยู่เต็ม

การปรับเสียงกรีง

สามารถเลือกระดับเสียงกรีงได้สามระดับ รวมถึงปิดเสียงด้วย ในโหมดสแตนด์บาย กดปุ่มเสียงกรีง บนหน่วยตัดฝุ่น (รูป F-9) หรือบนรีโมทคอนโทรล (รูป G-6) ซ้ำหลายๆ ครั้ง ทุกครั้งที่กดปุ่ม เสียงกรีงจะดังขึ้นตามลำดับต่อไป ระดับเสียงสูง (ไฟสว่างขึ้น) ระดับเสียงต่ำ (ไฟสว่างขึ้น) และไม่มีเสียง (ไฟดับลง)

ข้อสังเกต: การตั้งค่านี้ทำไม่ได้ในโหมดสลีปเมื่อเปิดใช้งานตั้งเวลาเปิดอัตโนมัติ

การระบุตำแหน่งหน่วยตัดฝุ่น

คุณลักษณะนี้มีประโยชน์ต่อการระบุตำแหน่งหน่วยตัดฝุ่น ซึ่งอาจมองไม่เห็นบนพื้นขนาดใหญ่ที่มีโต๊ะ ตู้ และอุปกรณ์ติดตั้งอื่น ๆ

กดปุ่มไฟบอกตำแหน่ง บนรีโมทคอนโทรล (รูป G-3) ขณะที่หน่วยตัดฝุ่นอยู่ในโหมดสแตนด์บายหรือโหมดสลีป เสียงกรีงจะดังประมาณ 10 วินาทีและไฟนำทางจะกะพริบ หากต้องการหยุดเสียงกรีง กดปุ่มไฟบอกตำแหน่ง อีกครั้ง

หมายเหตุ: อาจมีกรณีที่หน่วยตัดฝุ่นไม่ตอบสนอง เนื่องจากหน่วยตัดฝุ่นอยู่นอกระยะของรีโมทคอนโทรล สามารถแก้ปัญหานี้ได้โดยกดปุ่มไฟบอกตำแหน่ง ขณะที่คุณเคลื่อนที่ไปรอบๆ พื้นห้อง

การใช้ตั้งเวลาเปิดอัตโนมัติ

คุณลักษณะนี้ช่วยให้หน่วยตัดฝุ่นเริ่มทำงานอัตโนมัติหลังจากเวลาที่ระบุไว้ เนื่องจากมีการตั้งค่าจะถูกล้างเมื่อการทำตามความสะดวกแบบตั้งเวลาอัตโนมัติเสร็จสิ้นลง ให้ทำตามขั้นตอนต่อไปเพื่อเปิดใช้งานตั้งเวลาเปิดอัตโนมัติใหม่อีกครั้ง

1. ในโหมดสแตนด์บาย กดปุ่มตั้งเวลา บนหน่วยตัดฝุ่น (รูป F-6) หรือบนรีโมทคอนโทรล (รูป G-5) ซ้ำหลายๆ ครั้ง ทุกครั้งที่กดปุ่ม การตั้งค่าจะเปลี่ยนตามลำดับต่อไปนี้:

สถานะไฟ	เริ่มการทำความสะอาด
	หลังจาก 1 ชั่วโมง
	หลังจาก 3 ชั่วโมง
	หลังจาก 5 ชั่วโมง
	ไม่ใช้ตั้งเวลาเปิดอัตโนมัติ

2. กดปุ่ม POWER (รูป F-8) บนหน่วยตัดฝุ่นเพื่อเปิดใช้งานตั้งเวลาเปิดอัตโนมัติ หน่วยตัดฝุ่นจะเข้าสู่โหมดสลีป

หากต้องการล้างการตั้งเวลาในโหมดสแตนด์บาย กดปุ่ม POWER (รูป F-8) บนหน่วยตัดฝุ่นค้างไว้จนกระทั่งไฟแสดงสถานะทั้งหมดดับลงแล้ว หรือกดปุ่ม POWER OFF (รูป G-1) บนรีโมทคอนโทรล

ข้อสังเกต: หากสถานะของไฟแสดงสถานะแบตเตอรี่ทั้งซ้ายและขวาเป็น หรือ ตั้งเวลาเปิดอัตโนมัติอาจไม่ทำงานและการทำความสะอาดอาจไม่เริ่มต้นโดยอัตโนมัติ

ข้อสังเกต: ไม่สามารถเปลี่ยนแปลงการตั้งค่าและเริ่มการทำความสะอาดได้ในโหมดนี้

ข้อสังเกต: การตั้งค่าตั้งเวลาเปิดอัตโนมัติจะถูกล้างเมื่อแบตเตอรี่ปล่อยประจุจนหมด

การจำกัดหุ่นยนต์ดูดฝุ่นให้อยู่ในพื้นที่ที่กำหนด

เทปกั้นพื้นที่ (รูป L-1) และคุณสมบัติตรวจจับแนวพื้นที่ที่ใช้เซนเซอร์อินฟราเรด ช่วยให้หุ่นยนต์ดูดฝุ่นหลีกเลี่ยงพื้นที่ต่อไปนี้ (รูป L-2)

- พื้นที่ซึ่งแบ่งเป็นส่วนๆ เนื่องจากพื้นที่ทั้งหมดมีขนาดใหญ่เกินกว่าที่หุ่นยนต์ดูดฝุ่นจะสามารถทำความสะอาดทั้งชั้นได้ในคราวเดียวกัน
- พื้นที่ซึ่งมีสิ่งของแตกหักงายที่หุ่นยนต์ดูดฝุ่นสามารถทำได้เสียหายได้
- พื้นที่ซึ่งเต็มไปด้วยสิ่งของและอุปกรณ์ติดตั้ง แนวกัน หรือมีรูปร่างซับซ้อน ส่งผลให้หุ่นยนต์ดูดฝุ่นเข้าไปติด
- พื้นที่ซึ่งอยู่ใกล้บันได
- พื้นที่ซึ่งมีแนวกันต่ำที่หุ่นยนต์ดูดฝุ่นสามารถปีนข้ามและตกลงมายังชั้นล่าง หรือหุ่นยนต์ดูดฝุ่นจะเข้าไปติดอยู่บนนั้น

การเตรียมการ

1. เลือกพื้นที่ราบเรียบสม่ำเสมอบนพื้นที่ซึ่งคุณต้องการจะวางเทปกั้นพื้นที่ จากนั้นทำความสะอาดพื้นผิว
2. วางเทปกั้นพื้นที่ให้ด้านข้างซึ่งมีแถบด้านสันอยู่ติดกับพื้นที่ทำความสะอาดและไม่พองอากาศอยู่ระหว่างเทปและพื้น

ข้อสังเกต: ใช้แต่เทปกั้นพื้นที่ที่เป็นของแท้เท่านั้น การใช้เทปอื่นนอกเหนือจากเทปของแท้อาจเสี่ยงต่อการทำให้คุณสมบัตินี้ตรวจจับแนวพื้นที่ที่ทำงานผิดพลาด

ข้อสังเกต: อย่าวางเทปกั้นพื้นที่บนพื้นผิวขรุขระที่อาจทำให้การตรวจจับผิดพลาด หรือบนพื้นผิวที่เทปอาจเปื้อนหรือเสียหายได้

ข้อสังเกต: พึงทราบว่าการวางชนิดอาจหลงเหลืออยู่บนพื้นหรือพื้นอาจได้รับความเสียหายเมื่อดึงเทปกั้นพื้นที่ออก

ข้อสังเกต: รักษาความสะอาดของเทปกั้นพื้นที่และตรวจสอบว่ามีตำแหน่งใดมีขีดหรือสก๊อตเทป เปลี่ยนเทปถ้าหากเทปเสียหาย

คำเตือน: อย่าวางเทปกั้นพื้นที่ในพื้นที่ซึ่งอาจเกิดอุบัติเหตุจากการที่หุ่นยนต์ดูดฝุ่นเข้าไปในพื้นที่หรือหุ่นยนต์ดูดฝุ่นตกลงมาจากพื้นที่นั้น ในกรณีดังกล่าว ใหวางสิ่งของที่มีความสูง 15 ซม. หรือสูงกว่า หรือวัตถุที่หนักพอที่จะทนต่อแรงกระแทกของหุ่นยนต์ดูดฝุ่นได้ในเทปกั้นพื้นที่

การใช้งาน

ในโหมดสแตนด์บาย กดปุ่มเซนเซอร์ตรวจจับแนวพื้นที่ (รูป F-11) บนหน่วยตัดฝุ่นเพื่อเปิดใช้งานเซนเซอร์ตรวจจับแนวพื้นที่ (รูป O-2)

ไฟ (รูป F-11) สว่างขึ้น

หากต้องการปิดใช้งานเซนเซอร์ตรวจจับแนวพื้นที่ กดปุ่มเซนเซอร์ตรวจจับแนวพื้นที่ อีกครั้ง

ข้อสังเกต: การตั้งค่านี้ทำไม่ได้ในโหมดสลีปเมื่อเปิดใช้งานตั้งเวลาเปิดอัตโนมัติ

การบำรุงรักษา

ข้อควรระวัง: ตรวจสอบให้แน่ใจเสมอว่าด้ามแบตเตอรี่ทั้งสองถูกถอดออกแล้วก่อนพยายามที่จะทำการตรวจสอบหรือบำรุงรักษา

ข้อสังเกต: ตรวจสอบให้แน่ใจว่าได้นำกล่องเก็บฝุ่นออกก่อนที่จะคว่ำหุ่นยนต์ดูดฝุ่นลงเพื่อป้องกันไม่ให้ฝุ่นและสิ่งสกปรกหล่นออกมาจากรูปร่างหลัก

ข้อสังเกต: ตรวจสอบให้แน่ใจว่าได้ปัดพรมหรือเบาะรองประเกศอื่น ๆ บนพื้นเพื่อป้องกันไม่ให้เกิดความเสียหายแก่พื้นและหุ่นยนต์ดูดฝุ่น (รูป B)

ข้อสังเกต: ห้ามใช้น้ำร้อน (อุณหภูมิสูงกว่า 40°C) น้ำมัน เชื้อเพลิง น้ำมันเบนซิน เทนเนอร์ แอลกอฮอล์ หรืออย่างอื่นที่คล้ายกันโดยเด็ดขาด เพราะอาจทำให้เกิดการเปลี่ยนแปลงรูป หรือแตกร้าวได้

เพื่อให้ผลิตภัณฑ์ยังคงมีความปลอดภัยและเชื่อถือได้ การซ่อมแซมและการบำรุงรักษาอื่นใด หรือการปรับแต่งใดๆ จะต้องทำโดยศูนย์บริการจากโรงงานหรือศูนย์บริการที่ได้รับบริการแต่งตั้งของ Makita ซึ่งจะใช้อะไหล่ของ Makita เสมอ

การทำความสะอาดแปรงขัด (รูป A, M-1)

- เส้นด้ายและเส้นผมที่เข้าไปพันกับขนแปรงของแปรงขัดอาจเป็นเหตุให้แปรงหยุดหมุนได้ ใช้คีมหนีบหรือเครื่องมือที่คล้ายกันดึงสิ่งเหล่านี้ออก
- ถ้ายางแปรงเสียรูปหรือหลุด ให้เปลี่ยนไปใช้แปรงสำรอง (ดูรายละเอียดที่ "การติดตั้งแปรงขัด")

การทำความสะอาดล้อ

- ใช้เครื่องมือมือ เช่น คีมหนีบและกรรไกร ดึงเส้นด้ายและเส้นผมออกจากล้อเลื่อน (รูป M-2) หมุนล้อเพื่อช่วยให้ทำความสะอาดง่ายขึ้น
- ใช้เครื่องมือมือ เช่น คีมหนีบ กรรไกร และเครื่องมือที่คล้ายกัน ดึงเส้นด้ายและเส้นผมออกจากล้อหมุน (รูป M-3)

ข้อสังเกต: ต้องระมัดระวังไม่ให้นิ้วเข้าไปติดอยู่ระหว่างล้อและตัวเครื่องหุ่นยนต์ดูดฝุ่น

การทำความสะอาดแปรงหลัก

การถอดแปรงข้างออก (ดูรายละเอียดที่ "การติดตั้งแปรงข้าง") จะช่วยให้ทำงานต่อไปได้ง่ายขึ้น

1. ถอดสกรูสี่ตัว (รูป N-1) ตามด้วยแผ่นใต้เครื่อง (รูป N-2) และแปรงหลัก (รูป N-3) ออก
2. เช็ดแผ่นใต้เครื่อง (รูป N-2) ด้วยผ้าชุบน้ำผงซักฟอกอ่อนๆ พอหมาดๆ หรือนำแผ่นใต้เครื่องไปล้างน้ำถ้าจำเป็น
3. ใช้กรรไกรดึงเส้นด้ายและเส้นผมออกจากแปรงหลัก (รูป N-3) แล้วนำแปรงหลักไปล้างน้ำถ้าจำเป็น
4. เช็ดด้านในของช่องดูดฝุ่น (รูป N-4) ด้วยผ้าชุบน้ำผงซักฟอกอ่อนๆ พอหมาดๆ
5. การเปลี่ยนแปรงหลัก ทำได้โดยจัดส่วนที่ยื่นออกมา (รูป N-5) ทางปลายด้านขวาของแปรงหลักให้ตรงกับรอยเว้าบนปลอกแกนด้านขวา (รูป N-6) จากนั้นใส่แปรงหลักเพื่อเชื่อมต่อเข้าด้วยกัน
6. ใส่ปลายสี่เหลี่ยมด้านซ้ายของแปรงหลัก (รูป N-7) เข้าไปในปลอกแกนสี่เหลี่ยมด้านซ้าย (รูป N-8)
7. ใส่แผ่นใต้เครื่องตามลำดับย้อนกลับ

หมายเหตุ: เมื่อแปรงข้างยังคงติดอยู่กับตัวเครื่องหุ่นยนต์ดูดฝุ่น การหมุนแปรงข้างด้วยมือจะช่วยให้แปรงข้างติดกับแผ่นใต้เครื่องได้ดีขึ้นโดยไม่ต้องมีขนแปรงข้างระหว่างแผ่นใต้เครื่องและตัวเครื่องหุ่นยนต์ดูดฝุ่น

การทำความสะอาดเซ็นเซอร์

- ทำความสะอาดเซ็นเซอร์ป้องกันการตกจากที่สูง (รูป O-1) และเซ็นเซอร์ตรวจจับแนวพื้น (รูป O-2) ด้วยไม้พันสาลีสะอาดและแห้ง
- ทำความสะอาดเซ็นเซอร์อัลตราโซนิก (รูป P-1) โดยใช้เครื่องดูดฝุ่นเครื่องอื่นที่ตั้งไว้ในโหมดแรงดูดเบา ที่ด้านหน้าและทั้งสองข้างของกันชนมีเซ็นเซอร์ทั้งหมด 8 ตัว (รูป P-2)

การทำความสะอาดลูกกรองฝุ่นและกล่องเก็บฝุ่น

ข้อสังเกต: อย่าเปิดหรือปิดฝามบนของกล่องเก็บฝุ่นแรงๆ เพื่อป้องกันไม่ให้เกิดความเสียหาย

1. ปลดล็อกทั้งสองด้าน (รูป Q-1) แล้วยกฝามบนของกล่องเก็บฝุ่นพร้อมทั้งจับเครื่องมือหมาบบำรุงรักษาของกล่องฝุ่น  (รูป Q-2) ไว้เพื่อเปิดช่องใส่ลูกกรองฝุ่น
2. นำลูกกรองฝุ่น (รูป Q-3) ออกแล้วเคาะเบาๆ กับถุงขยะหรือแผ่นรองของที่ปูบนพื้นราบเพื่อสลัดฝุ่นและสิ่งสกปรกออก

ข้อสังเกต: อย่าขีดหรือบีบลูกกรองฝุ่น หรือใช้ของมีคมทำความสะอาดลูกกรองฝุ่น

3. ล้างลูกกรองฝุ่นด้านแรงดูดของหุ่นยนต์ดูดฝุ่นเบาๆ

ข้อสังเกต: หากลูกกรองฝุ่นมีกลิ่น ให้แช่ในสารละลายน้ำยาฟอกขาวที่ใช้ในครัวเรือน (น้ำยาฟอกขาว 10 มิลลิลิตรต่อน้ำ 1 ลิตร) ประมาณ 3 ชั่วโมงก่อนล้างลูกกรองฝุ่นในน้ำอีก

4. ล้างกล่องเก็บฝุ่น
5. นำลูกกรองฝุ่นและกล่องเก็บฝุ่นไปผึ่งในแห้ง (กรณีล้าง) เป็นเวลา 1 วันในสถานที่ที่อากาศถ่ายเทได้ดี เพื่อป้องกันกลิ่นอับหรือการทำงานผิดปกติ

ข้อสังเกต: อย่าทำให้ลูกกรองฝุ่นแห้งโดยใช้เป่าผมหรือแหล่งความร้อนอื่นๆ

6. ใส่ลูกกรองฝุ่นในกล่องเก็บฝุ่นตามลำดับย้อนกลับ



ข้อสังเกต: เมื่อเปลี่ยนลูกกรองฝุ่นในช่องใส่ ตรวจสอบให้แน่ใจว่าแอมป์ (รูป Q-4) บนลูกกรองฝุ่นพอดีกับรอยเว้าที่ขอบของที่ยึดลูกกรองฝุ่น (รูป Q-5)

การทำความสะอาดตัวเครื่อง



1. ใช้ผ้าชุบน้ำผงซักฟอกอ่อนๆ พอหมาดๆ เช็ดด้านนอกหุ่นยนต์ดูดฝุ่น
2. กดและปลดฝามบน (รูป K-1) เพื่อปลดล็อก จากนั้นเปิดฝาให้อากาศระบายออก
3. นำกล่องเก็บฝุ่นออกมา (รูป K-2)
4. ใช้ผ้าชุบน้ำผงซักฟอกอ่อนๆ พอหมาดๆ เช็ดด้านในหุ่นยนต์ดูดฝุ่น (รูป R-1) รวมถึงตะแกรงระบายอากาศ (รูป R-2)

การกักันการทำงานของหุ่นยนต์ดูดฝุ่น

เมื่อหุ่นยนต์ดูดฝุ่นไม่สามารถทำงานต่อไปในสภาวะอย่างเช่น ล้อเลื่อนหลุด หรือไม่มีพลังงานแบตเตอรี่ หุ่นยนต์ดูดฝุ่นจะหยุดการทำงานสะอาดและแจ้งให้ทราบว่ามีสิ่งผิดปกติด้วยไฟเสียงกระดิ่งต่อไปนี้

















-  ไฟการแก้ไขปัญหาเบื้องต้น (รูป F-2)
-  ไฟการบำรุงรักษาของลูกกรองฝุ่น (รูป F-3)

- ☀️ ไฟการบำรุงรักษาแปร่ง (รูป F-4)
- 🕒 ไฟตั้งเวลา (รูป F-6)
- 🔊 ไฟเสียงกริ่ง (รูป F-9)
- 🔌 ไฟจุดฝุ่น (รูป F-10)
- 🔍 ไฟเซนเซอร์ตรวจจับแนวพื้นที่ (รูป F-11)

1. ระบุปัญหาโดยใช้ตารางต่อไปนี้
2. แก้ไขปัญหา
3. กดปุ่ม  POWER (รูป F-8) บนหุ่นยนต์ดูดฝุ่นหรือปุ่ม  เริ่ม/หยุด (รูป G-2) บนรีโมทคอนโทรลเพื่อเข้าสู่โหมดสแตนด์บาย
อาการของข้อผิดพลาดหยุดลงและหุ่นยนต์ดูดฝุ่นพร้อมแล้วสำหรับการทำความสะอาด

ข้อสังเกต: หากเกิดข้อผิดพลาดขึ้นอีกครั้ง ให้ปิดและเปิดหุ่นยนต์ดูดฝุ่น

ข้อสังเกต: หากปัญหายังคงอยู่หลังทำการแก้ไขเสร็จแล้ว ให้ปรึกษาศูนย์บริการ Makita ใกล้บ้านคุณ

อาการ	สาเหตุ/การแก้ไข
ไฟ  กระพริบหนึ่งครั้ง สองครั้ง หรือ 6 ครั้ง ต่อเนื่องกันในแต่ละลำดับ	<ul style="list-style-type: none"> • ล้อเลื่อนหลุด • หุ่นยนต์ดูดฝุ่นเข้าไปติดในแนวกัน • หุ่นยนต์ดูดฝุ่นถูกแสงแดดโดยตรง • หุ่นยนต์ดูดฝุ่นหยุดบนพื้นลื่น <p>→ ย้ายหุ่นยนต์ดูดฝุ่นออกจากบริเวณนั้น</p> <p>→ หากเกิดข้อผิดพลาดขึ้นอีก ให้ทำความสะอาดเซนเซอร์ป้องกันการตกจากที่สูง (รูป O-1)</p>
ไฟ  กระพริบ 3 ครั้ง ต่อเนื่องกันในแต่ละลำดับ	<ul style="list-style-type: none"> • เกิดข้อผิดพลาดของเซนเซอร์กันชน <p>→ กดกันชน (รูป P-2) 10 ครั้ง</p>
ไฟ  กระพริบ 4 ครั้ง ต่อเนื่องกันในแต่ละลำดับ	<ul style="list-style-type: none"> • เส้นสายและเส้นผมเข้าไปพันกับล้อเลื่อน • นำเส้นสายและเส้นผมออกจากล้อเลื่อน (รูป M-2) • หุ่นยนต์ดูดฝุ่นผ่านพื้นที่แคบซึ่งพื้นผิวค้ำบนถูกกดลง <p>→ มีไม้ใช้การทำงานปิดปกติ</p>
ไฟ  กระพริบ 5 หรือ 7 ครั้ง ต่อเนื่องกันในแต่ละลำดับ	<ul style="list-style-type: none"> • หุ่นยนต์ดูดฝุ่นร้อนจัด <p>→ ปิดหุ่นยนต์ดูดฝุ่น ถอดปลั๊กแบตเตอรี่ออกแล้วรอกหนึ่งชั่วโมง ใช้หุ่นยนต์ดูดฝุ่นที่อุณหภูมิห้องไม่เกิน 40°C เท่านั้น</p>
ไฟ  และ  กระพริบหนึ่งครั้งต่อเนื่องกันในแต่ละลำดับ	<ul style="list-style-type: none"> • ไม้ใส่ใส่กล่องเก็บฝุ่นหรือถุงกรองฝุ่น <p>→ ใส่กล่องเก็บฝุ่นหรือถุงกรองฝุ่น</p>
ไฟ  และ  ทั้งหมด กระพริบหนึ่งครั้งต่อเนื่องกันในแต่ละลำดับ	<ul style="list-style-type: none"> • ไฟแบตเตอรี่ที่เหลือน้อยในเพียงพอ ( หรือ ) จะเริ่มการทำงานสะอาด <p>→ ชาร์จกลับแบตเตอรี่จนเต็ม</p>
ไฟ  และ  สว่างขึ้น	<ul style="list-style-type: none"> • เส้นสายและเส้นผมเข้าไปพันกับล้อเลื่อน • นำเส้นสายและเส้นผมออกจากล้อเลื่อน (รูป M-2) • หุ่นยนต์ดูดฝุ่นผ่านพื้นที่แคบซึ่งพื้นผิวค้ำบนถูกกดลง <p>→ มีไม้ใช้การทำงานปิดปกติ</p>
ไฟ  และ  สว่างขึ้น	<ul style="list-style-type: none"> • เกิดข้อผิดพลาดของเซนเซอร์ <p>→ ปิดหุ่นยนต์ดูดฝุ่นและเปิด</p>
ไฟ  และ  สว่างขึ้น	<ul style="list-style-type: none"> • เกิดข้อผิดพลาดในหุ่นยนต์ดูดฝุ่น <p>→ ปิดหุ่นยนต์ดูดฝุ่นและเปิด</p>
ไฟ  กระพริบหนึ่งครั้งต่อเนื่องกันในแต่ละลำดับ	<ul style="list-style-type: none"> • เส้นสายและเส้นผมเข้าไปพันกับแปรงข้างและแปรงหลัก <p>→ นำเส้นสายและเส้นผมออกจากแปรง (รูป A, N-3)</p>

ไฟ  สว่างขึ้น	<ul style="list-style-type: none"> • กล่องเก็บฝุ่นเต็มไปด้วยฝุ่นและสิ่งสกปรกหรือถุงกรองฝุ่นอุดตัน → เทฝุ่นในกล่องเก็บฝุ่น (รูป K-2) และทำความสะอาดถุงกรองฝุ่น (รูป K-5)
---	---

การแก้ไขปัญหาเบื้องต้น

หมายเหตุ: หากปัญหายังคงอยู่หลังดำเนินการแก้ไขแล้ว ให้ปรึกษาศูนย์บริการ Makita ใกล้บ้านคุณ

อาการ	สาเหตุ/การแก้ไข
ไฟไม่ติดสว่างเมื่อกดปุ่ม  หุ่นยนต์ดูดฝุ่นไม่ทำงานเมื่อกดปุ่มบนหุ่นยนต์ดูดฝุ่นหรือรีโมทคอนโทรล	<ul style="list-style-type: none"> → ดัดตั้งลิ้นแบตเตอรี่ให้ถูกต้อง → ชาร์จกลับแบตเตอรี่จนเต็ม → กดปุ่ม  เพื่อเปิดสวิตช์หุ่นยนต์ดูดฝุ่น
หุ่นยนต์ดูดฝุ่นไม่ทำงาน	<ul style="list-style-type: none"> → ถ้าไฟการแก้ไขปัญหาเบื้องต้น  ไฟการบำรุงรักษาถุงกรองฝุ่น  หรือไฟการบำรุงรักษาแปร่ง  สว่างขึ้นหรือกระพริบ ให้ดูวิธีการแก้ไขปัญหาที่ "การกีดกันการทำงานของหุ่นยนต์ดูดฝุ่น" → ถ้าไฟผ่านทางกระพริบซ้ำ ให้กดปุ่ม  POWER บนหุ่นยนต์ดูดฝุ่นค้างไว้จนกระทั่งไฟแสดงสถานะทั้งหมดดับลง หรือกดปุ่ม  POWER OFF บนรีโมทคอนโทรลเพื่อล้างการตั้งเวลา
หุ่นยนต์ดูดฝุ่นเริ่มการทำงานโดยอัตโนมัติ	<ul style="list-style-type: none"> • ตั้งเวลาเปิดอัตโนมัติถูกเปิดใช้งาน
หุ่นยนต์ดูดฝุ่นหยุดทำงานระหว่างการทำความสะอาด	<ul style="list-style-type: none"> → ปิดหุ่นยนต์ดูดฝุ่น ดึงสายไฟ สายช็อก ฯลฯ ออกจากปลั๊กเสียบ → ถ้าหุ่นยนต์ดูดฝุ่นเข้าไปติดกับแนวกันหรือสิ่งกีดขวางอื่นๆ ให้ย้ายหุ่นยนต์ดูดฝุ่นไปยังสถานที่อื่น
ความเร็วในการเคลื่อนที่ไม่คงที่	<ul style="list-style-type: none"> • ถ้ามีการตรวจพบสิ่งกีดขวาง หุ่นยนต์ดูดฝุ่นจะเคลื่อนที่ช้าลงเนื่องจากต้องใช้เวลาในการคำนวณทิศทางการเดินทาง มีไม้ใช้การทำงานปิดปกติของหุ่นยนต์ดูดฝุ่น
หุ่นยนต์ดูดฝุ่นไม่เดินทางตรงไปข้างหน้า	<ul style="list-style-type: none"> → ปิดหุ่นยนต์ดูดฝุ่น และดึงวัตถุแปลกปลอมที่เข้าไปพันกับล้อเลื่อนออก → ทำความสะอาดเซนเซอร์อัลตราโซนิก
หุ่นยนต์ดูดฝุ่นชนสิ่งกีดขวางบ่อยกว่าที่เคยเป็น	<ul style="list-style-type: none"> → ทำความสะอาดเซนเซอร์ป้องกันการตกจากที่สูง • หุ่นยนต์ดูดฝุ่นอาจไม่หลีกเลี่ยงระดับที่แตกต่างกัน 5.5 ซม. หรือมีอายุกว่า มีไม้ใช้การทำงานปิดปกติของหุ่นยนต์ดูดฝุ่น
เสียงการทำงานดังกว่าปกติ	<ul style="list-style-type: none"> → เทฝุ่นในกล่องเก็บฝุ่นและทำความสะอาดถุงกรองฝุ่น แปรงข้าง และแปรงหลัก
แรงดูดไม่มากพอที่จะจับฝุ่นและสิ่งสกปรก	<ul style="list-style-type: none"> → เทฝุ่นในกล่องเก็บฝุ่นและทำความสะอาดถุงกรองฝุ่น → กดปุ่มดูดฝุ่น  บนหุ่นยนต์ดูดฝุ่นหรือบนรีโมทคอนโทรลเพื่อเปิดพัดลมดูดฝุ่น
แปรงข้างหลุดออก	<ul style="list-style-type: none"> → ดัดตั้งแปรงข้างให้ถูกต้อง (รูป A)
แปรงข้างไม่หมุนหรือหมุนยาก	<ul style="list-style-type: none"> → ทำความสะอาดแปรงข้างและแปรงหลัก → ดัดตั้งแปรงหลักและแผ่นใต้เครื่องให้ถูกต้อง (รูป N)
ลมถ่ายออกมีกลิ่น	<ul style="list-style-type: none"> → เทฝุ่นในกล่องเก็บฝุ่นและทำความสะอาดถุงกรองฝุ่น

รีโมทคอนโทรลไม่ทำงาน	<ul style="list-style-type: none"> → ใส่แบตเตอรี่รีโมทคอนโทรลให้ถูกต้อง (รูป E) → เปลี่ยนเป็นแบตเตอรี่ก้อนใหม่ → กดปุ่ม  POWER บนหุ่นยนต์ดูดฝุ่นเพื่อเปิดสวิตซ์การทำงาน → ขยับเข้าไปใกล้ๆ หุ่นยนต์ดูดฝุ่นหรือนำสิ่งกีดขวางระหว่างหุ่นยนต์ดูดฝุ่นกับรีโมทคอนโทรลออก → หยุดใช้งานหุ่นยนต์ดูดฝุ่นใกล้กับ หรือ ย้ายออกห่างจากอุปกรณ์ที่ใช้แถบคลื่นความถี่วิทยุ 2.4 GHz (ไมโครเวฟห้องครัว อุปกรณ์บลูทูธ อุปกรณ์ Wi-Fi ฯลฯ) → ปิดหุ่นยนต์ดูดฝุ่นและเปิด
ตั้งเวลาเปิดอัตโนมัติไม่ทำงาน	<ul style="list-style-type: none"> → ใช้ถัสนับแบตเตอรี่ที่ชาร์จจนเต็ม → เปิดใช้งานตั้งเวลาเปิดอัตโนมัติอีกครั้ง

อุปกรณ์เสริมที่เลือกได้

⚠ ข้อควรระวัง: แนะนำให้ใช้อุปกรณ์เสริมหรือส่วนต่อเพิ่มเหล่านี้กับเครื่องมือ Makita ของคุณที่ระบุในคู่มือนี้ การใช้ อุปกรณ์เสริมหรือส่วนต่อเพิ่มอื่นใดอาจทำให้เสี่ยงต่อการบาดเจ็บได้ ใช้อุปกรณ์เสริมหรือส่วนต่อเพิ่มเพื่อจุดประสงค์ตามที่ได้ระบุไว้เท่านั้น

- เทปกั้นพื้นที่
- แปร่งข้าง
- แปร่งหลัง
- แผ่นใต้เครื่อง
- ถังกรองฝุ่น
- แบตเตอรี่และเครื่องชาร์จของแท้ของ Makita

หมายเหตุ: อุปกรณ์บางอย่างที่อยู่ในรายการอาจรวมอยู่ในชุดบรรจุภัณฑ์เครื่องมือเป็นอุปกรณ์เสริมมาตรฐาน และอาจแตกต่างกันไปในแต่ละประเทศ

ข้อมูลอ้างอิง

Makita Corporation และบริษัทในเครือ บริษัทสาขา และตัวแทนจำหน่ายสามารถใช้ "ข้อมูลการใช้งาน" เพื่อจุดประสงค์ในการให้บริการหลังการขาย เช่น การบำรุงรักษาและการซ่อมแซม ข้อมูลการใช้งานประกอบด้วยการทำงานจำนวนหนึ่ง ภาระในการแจกจ่าย ข้อมูลข้อผิดพลาด สถานะการทำงาน และ/หรือบันทึกการบำรุงรักษาเครื่องมือไฟฟ้า

Makita Corporation
3-11-8, Sumiyoshi-cho,
Anjo, Aichi 446-8502 Japan
www.makita.com

DRC200-ASIA7L-1610

IDE

Printed in Thailand

TINSJA599VBRZ 16K- (TH) ①